



BIONICLE®

71311







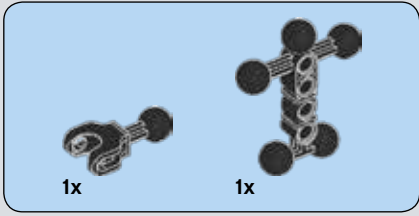
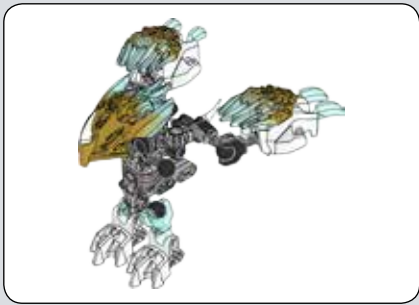

1

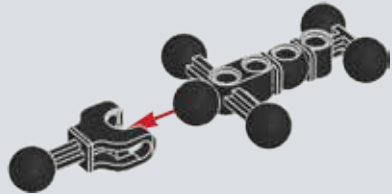

2

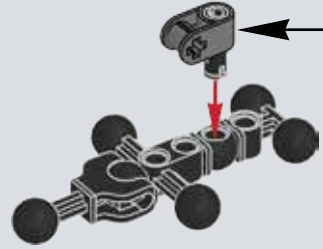
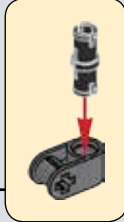

3

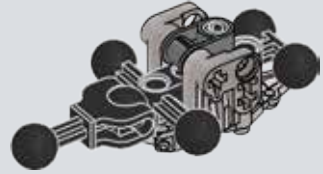

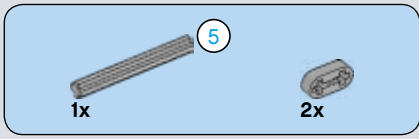

4

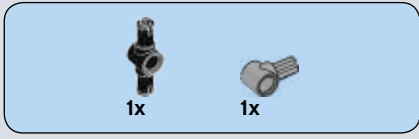
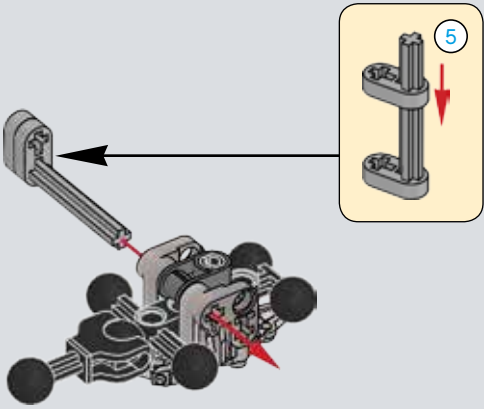

5

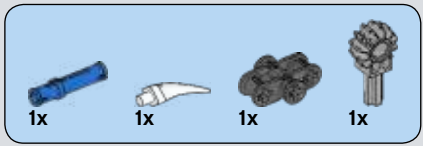
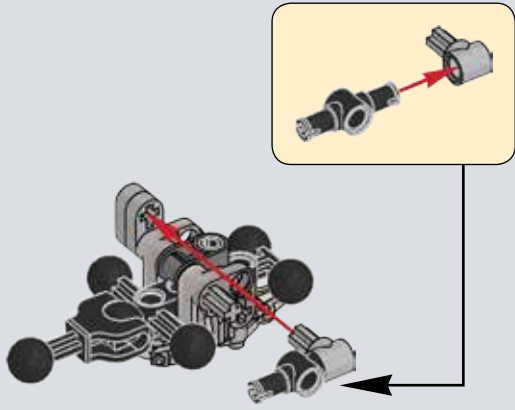

6

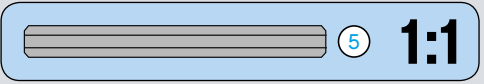
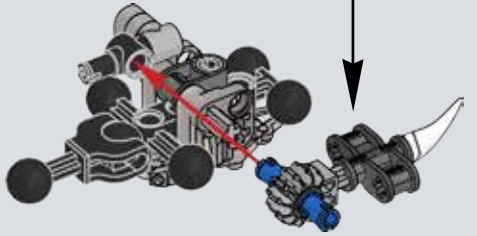
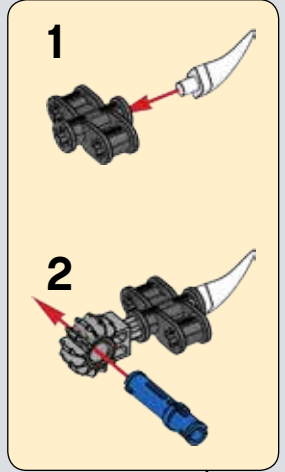



1x



1x

7

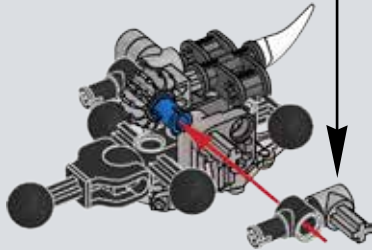
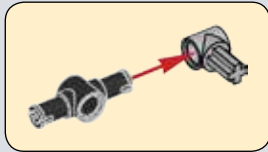

2x

8

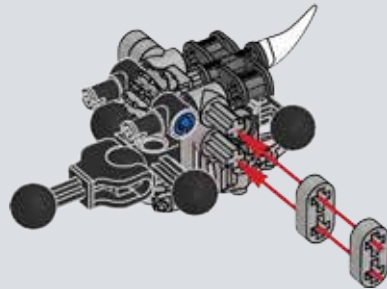

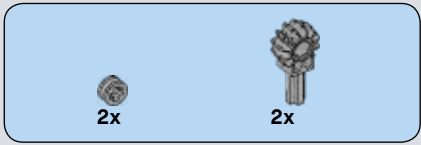

9

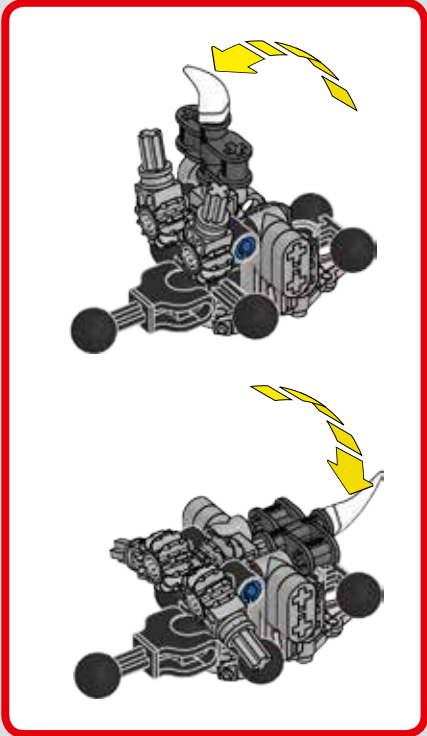
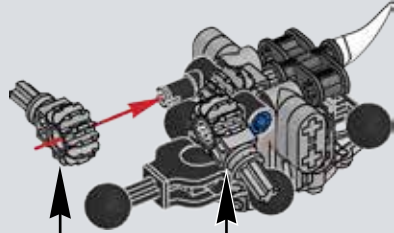
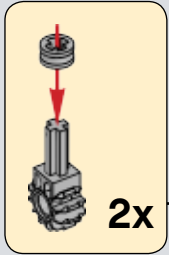

10

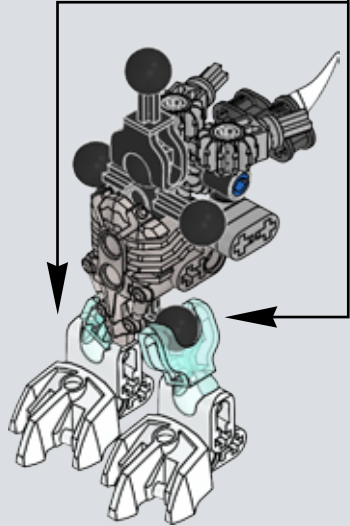
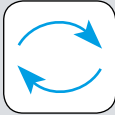
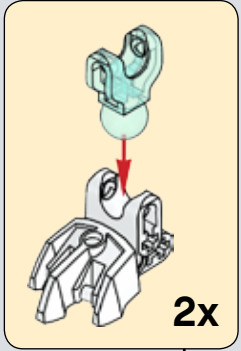

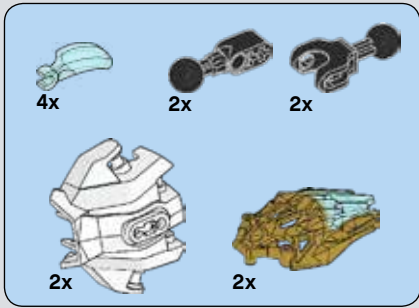

11

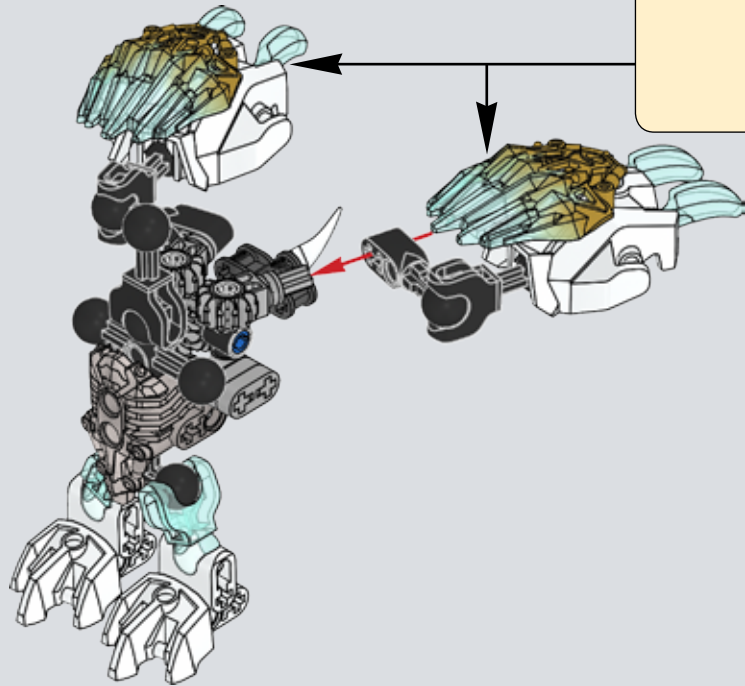
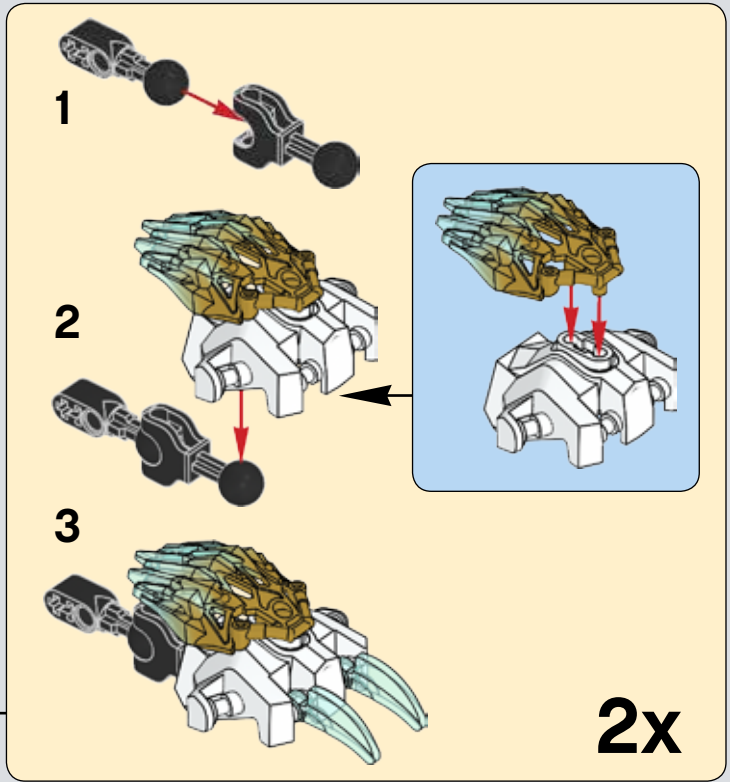

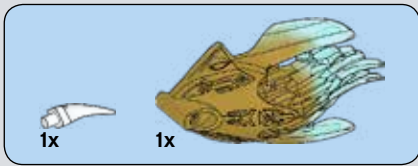

12

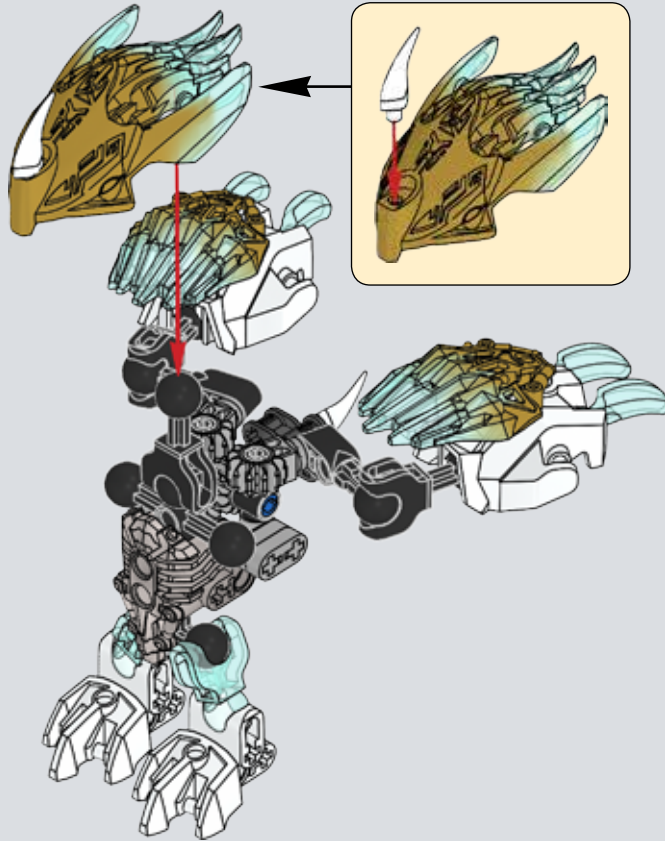
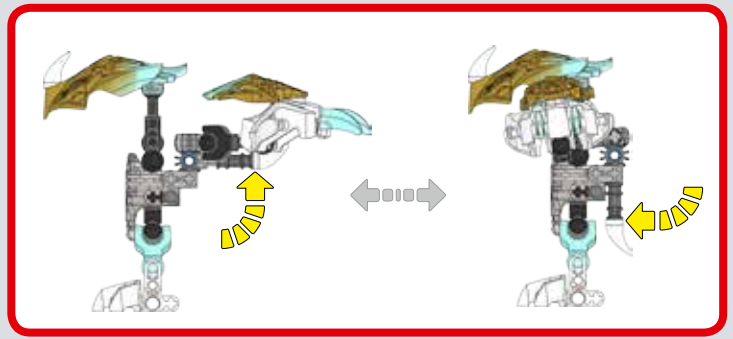

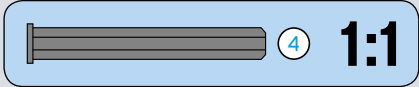
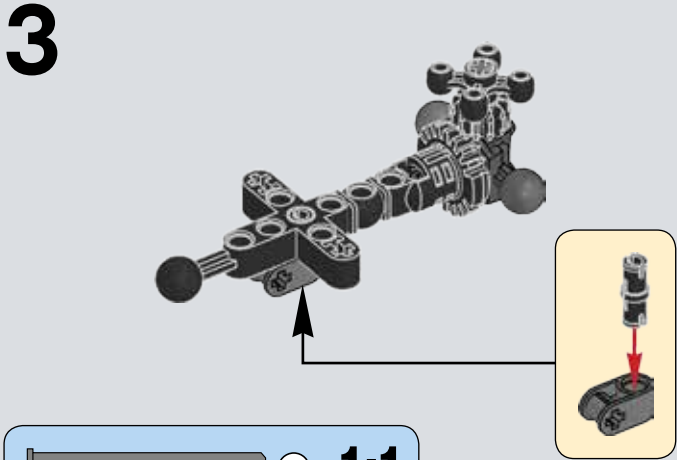
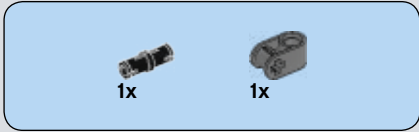
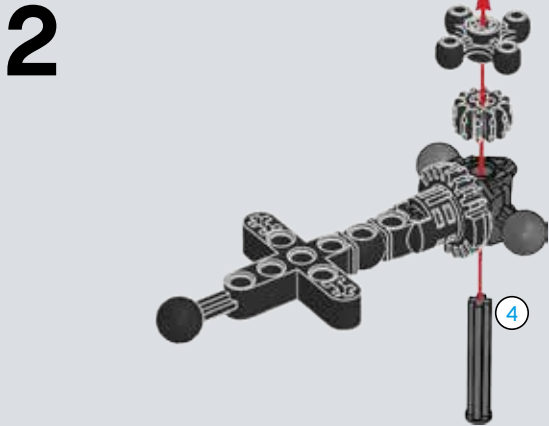
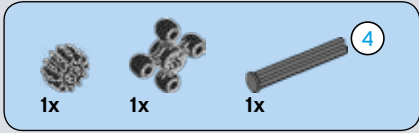
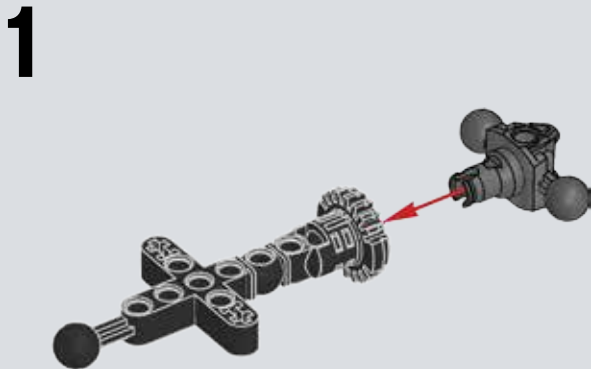
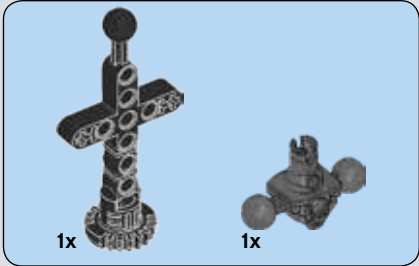



4

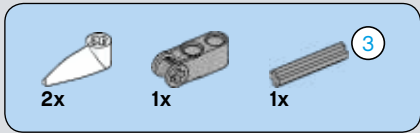
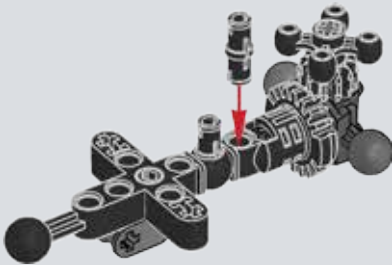

5

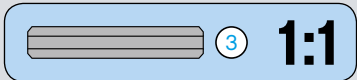
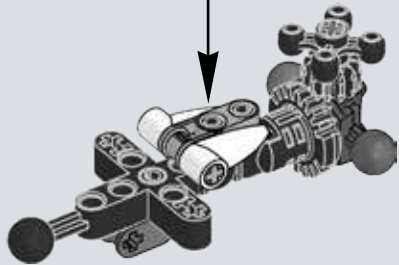
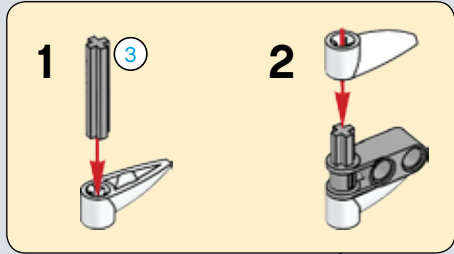



1x

6

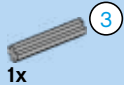
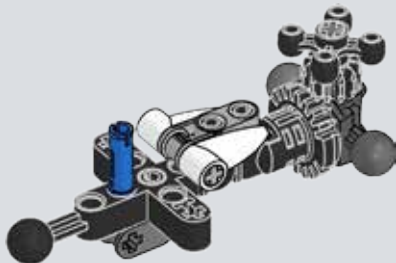

1x

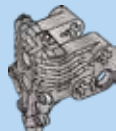

1x

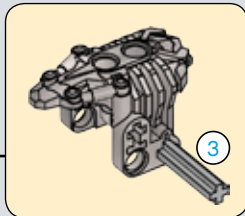

7

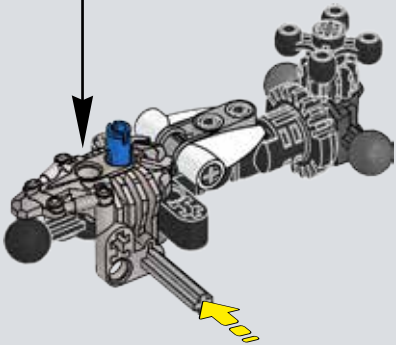

1x

8

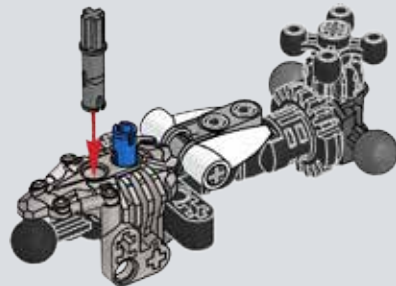

3

1:1

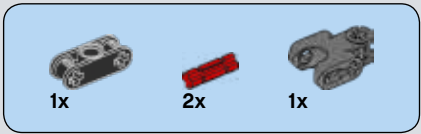

9

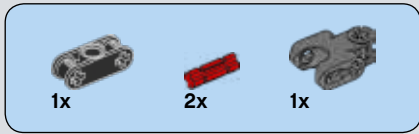
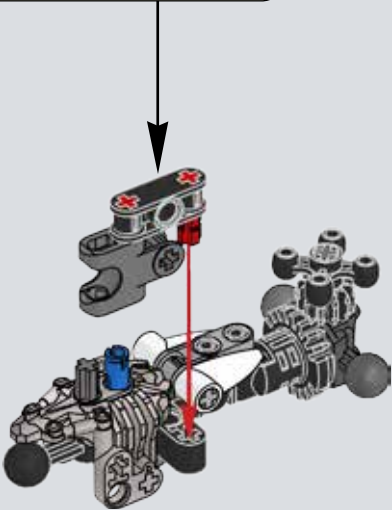
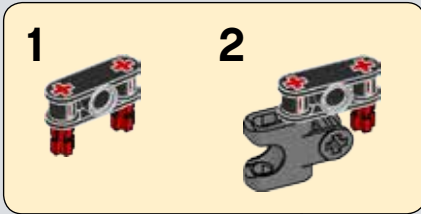

10

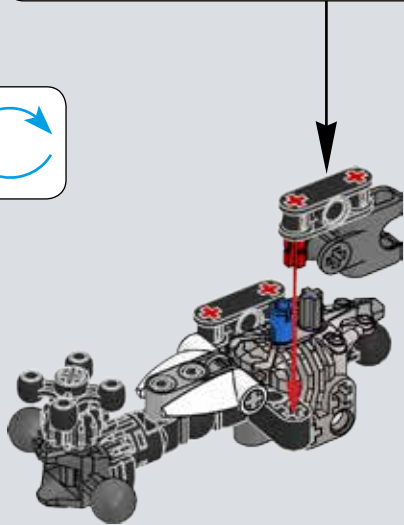
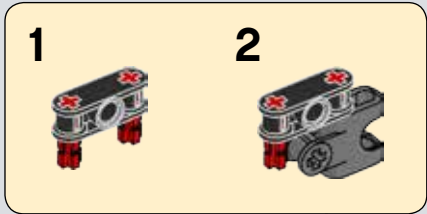

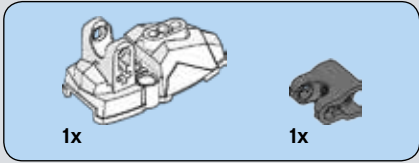

11

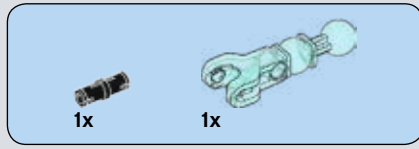
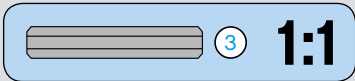
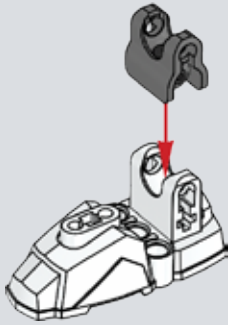

12

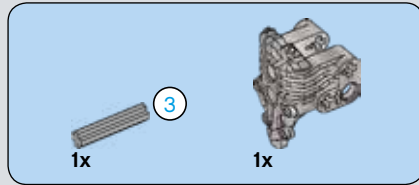
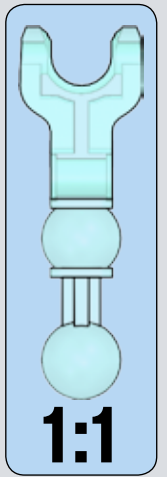
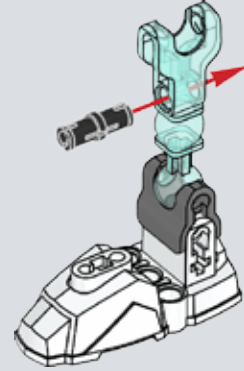

13

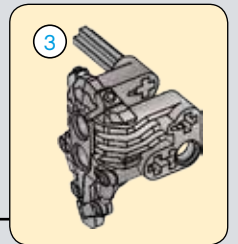
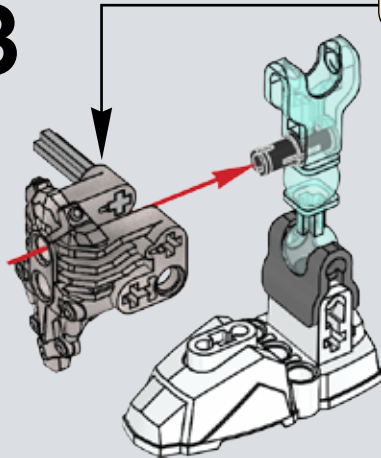



14

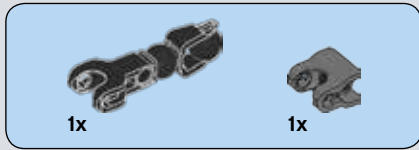
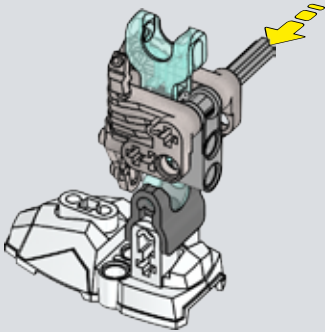
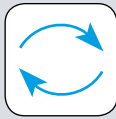

15

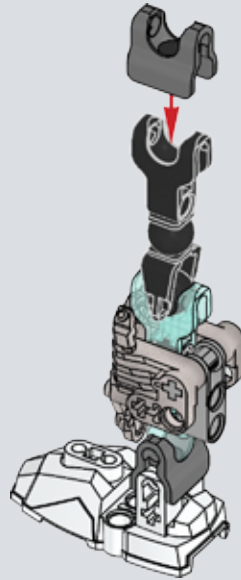

2x

16

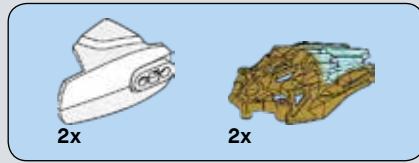
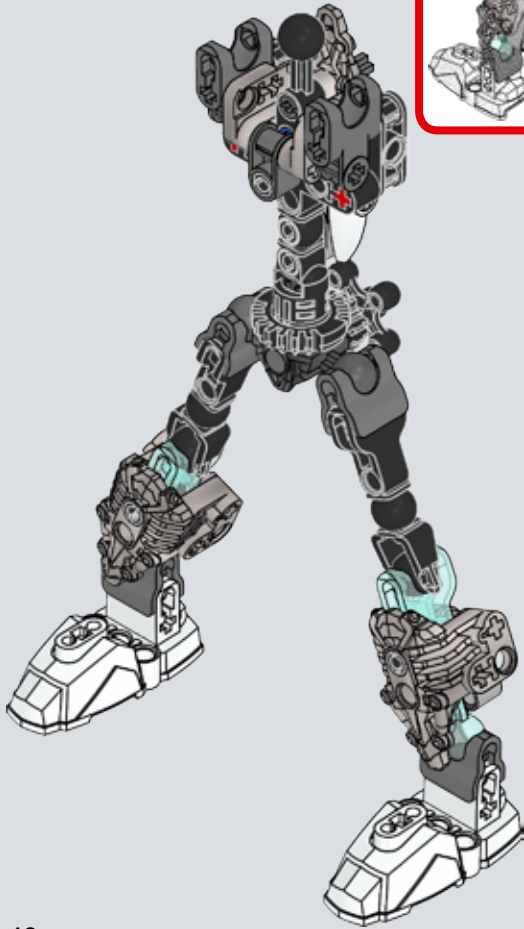
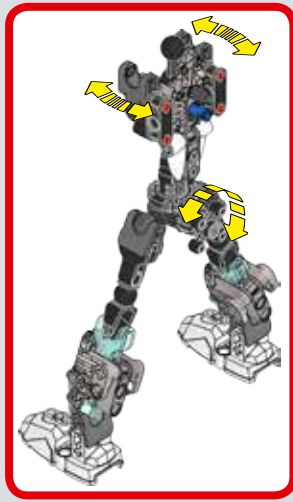

17

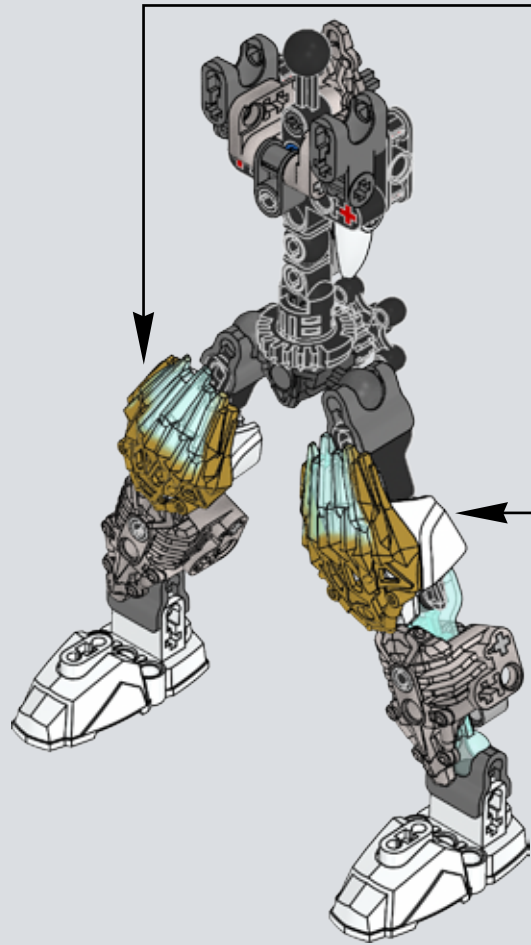
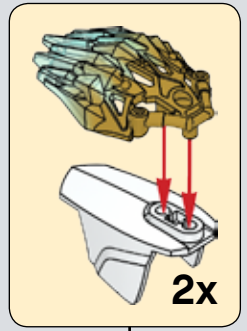



18

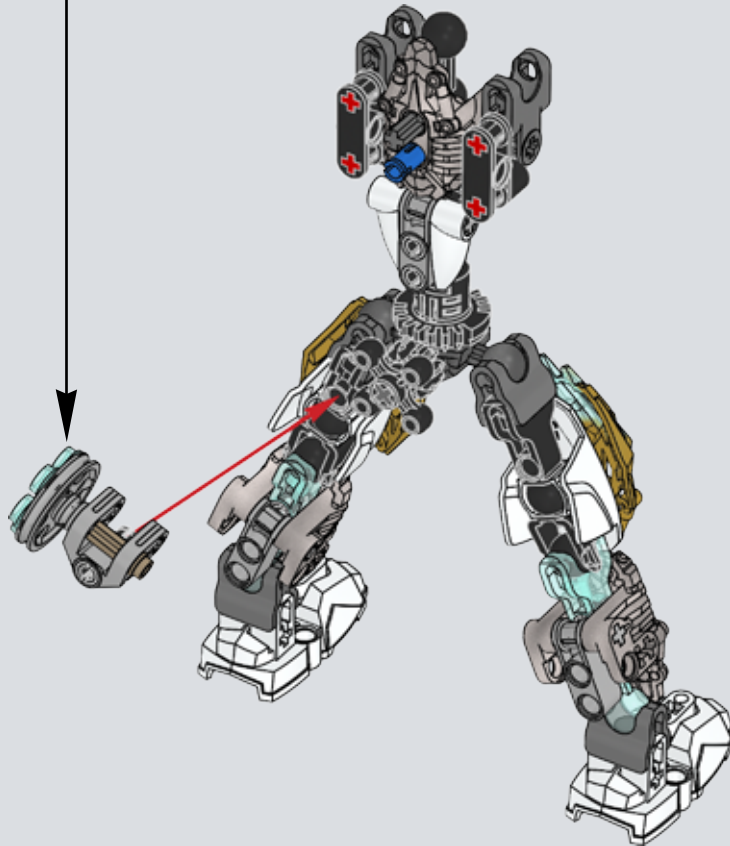
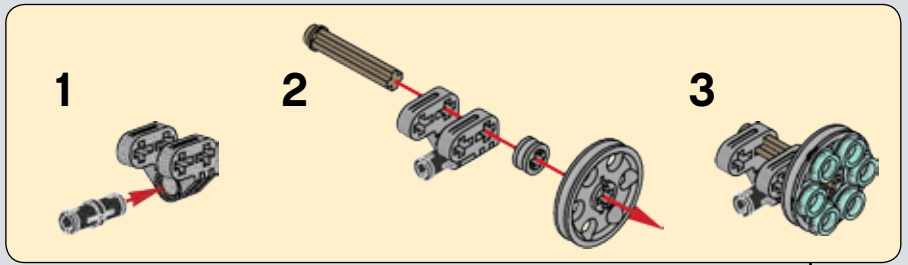

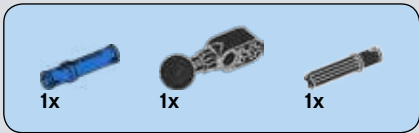
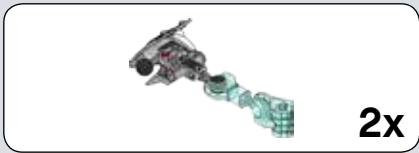

19

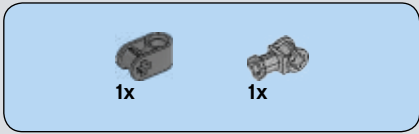
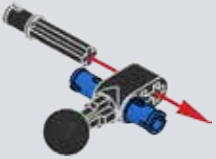

20

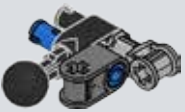

21

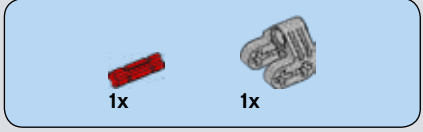
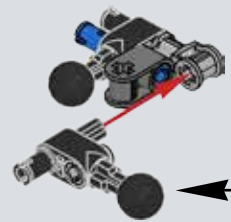
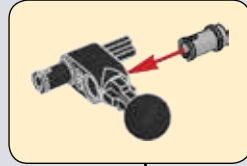

22

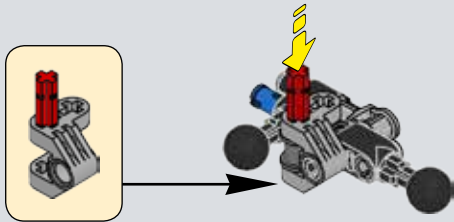

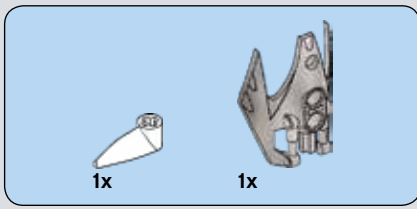

23

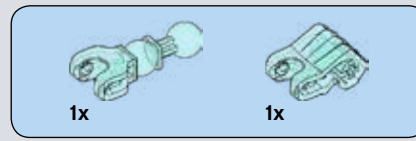
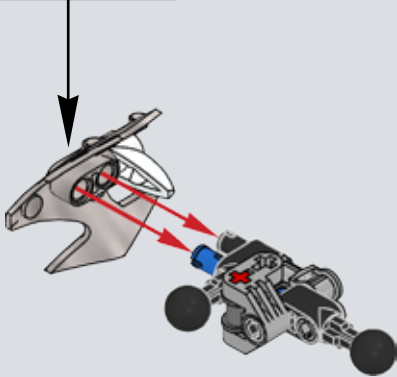
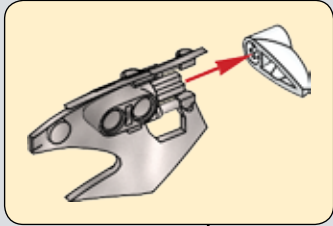

24

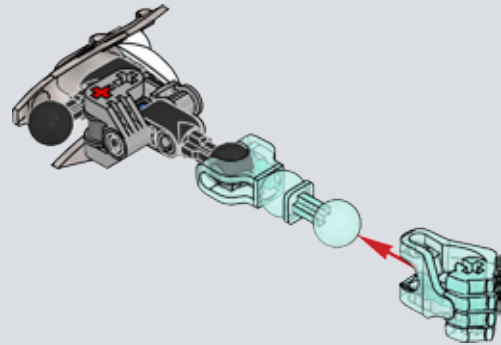

2x

25

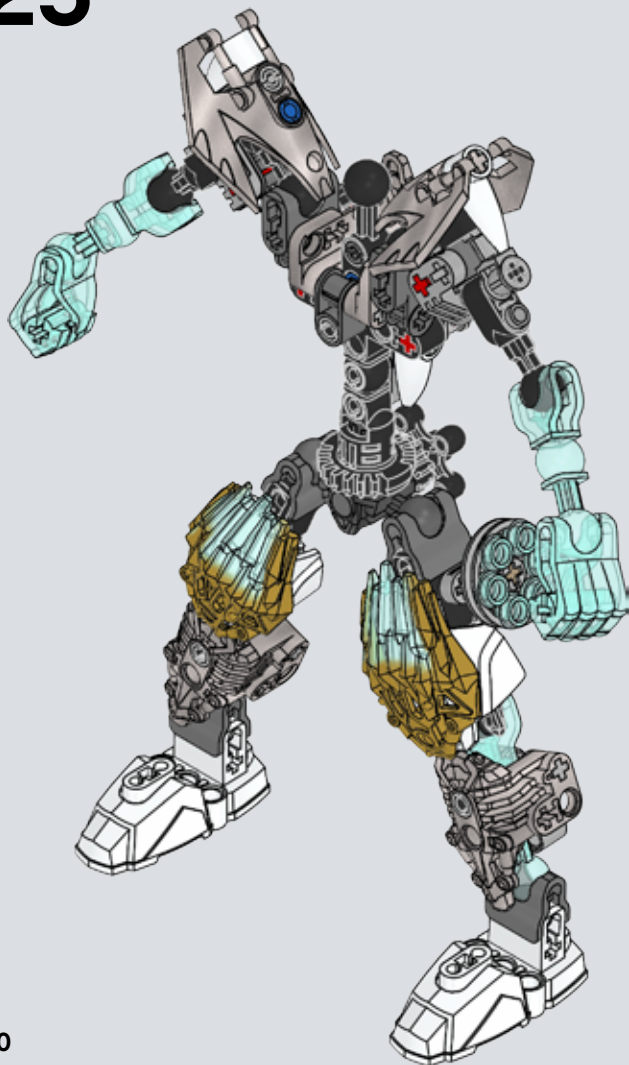

26

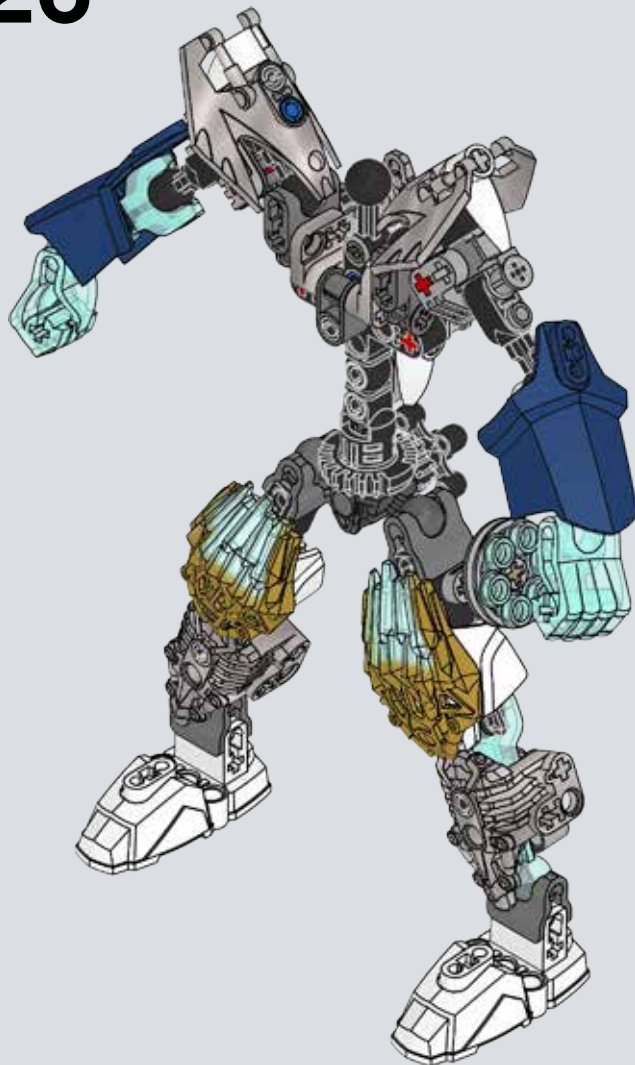

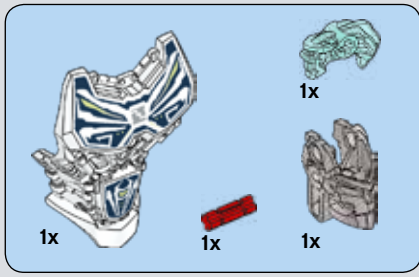

27

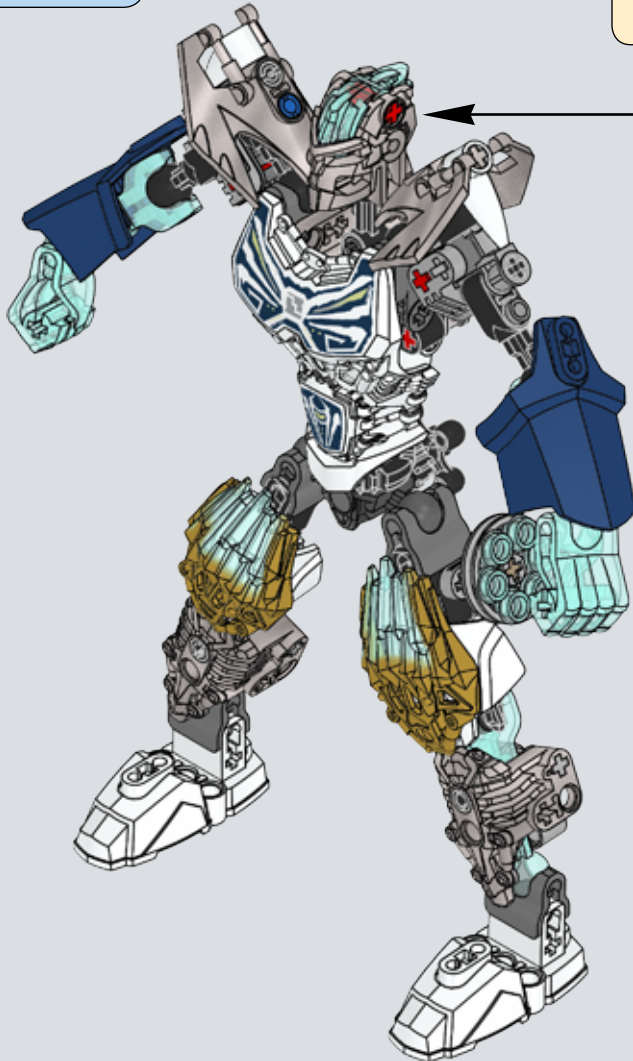
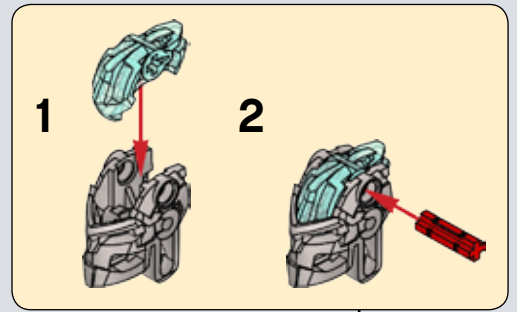



28

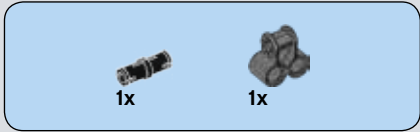

29

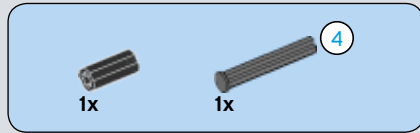
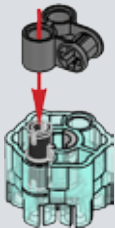

30

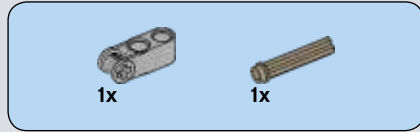
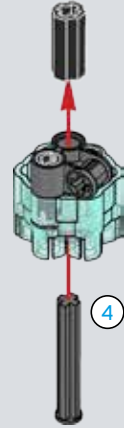

31

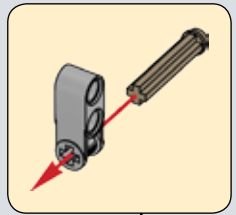

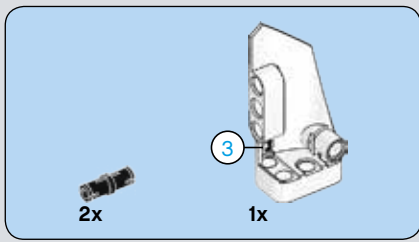

32

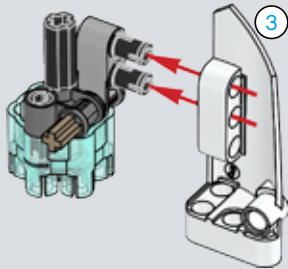

33

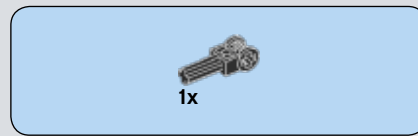
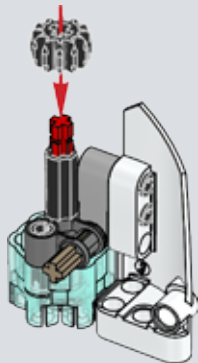

34

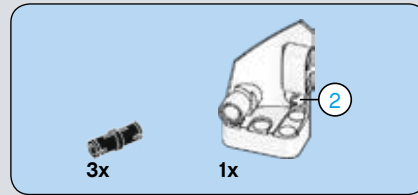
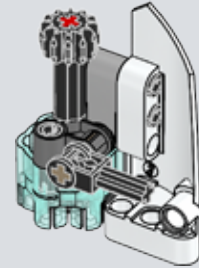

35

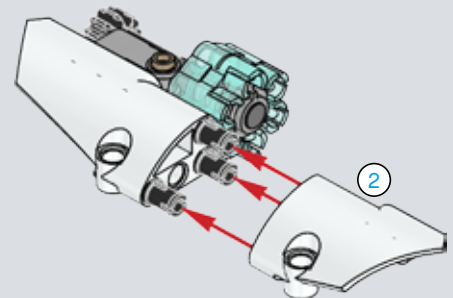
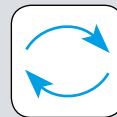

6x

36

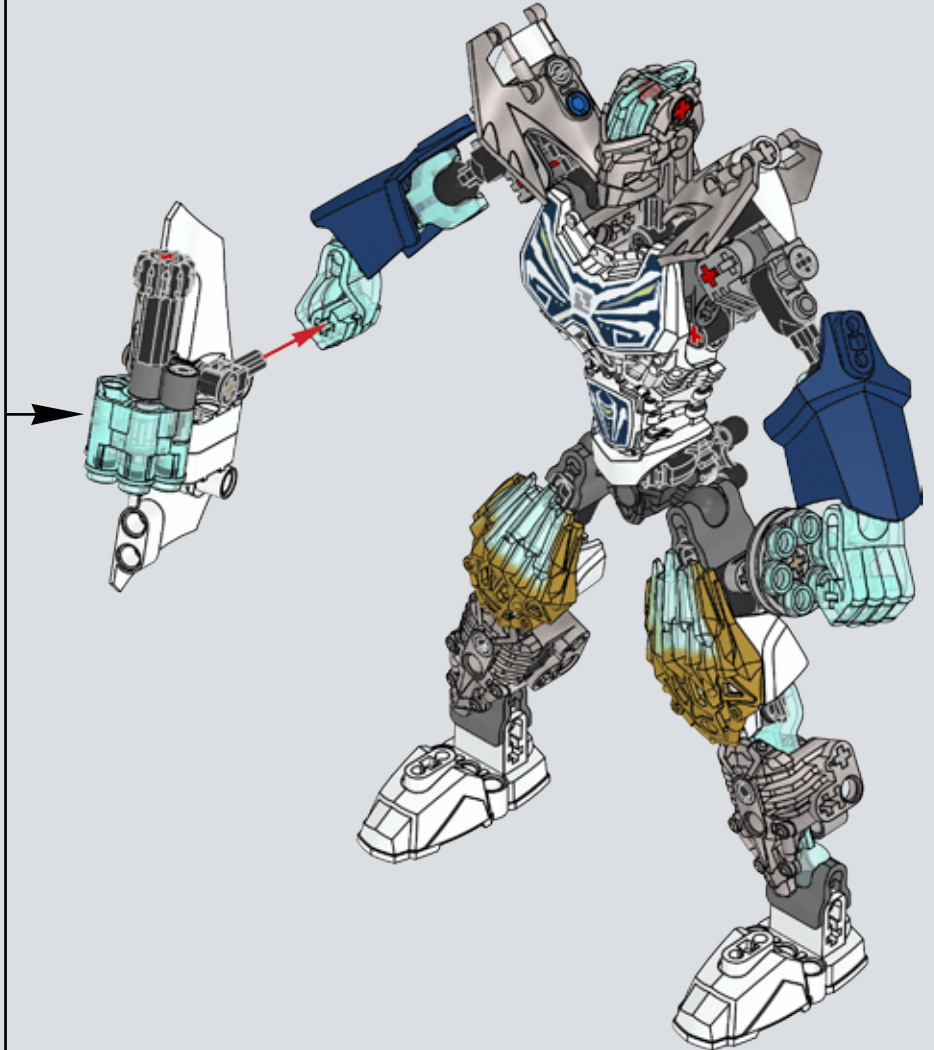
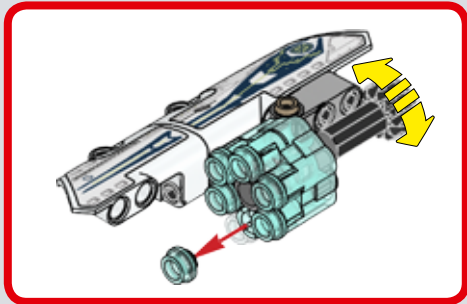
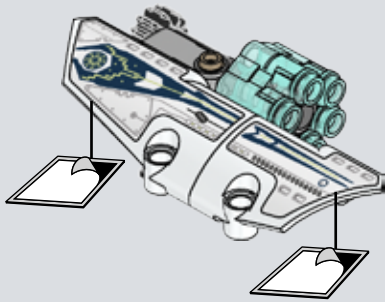



37

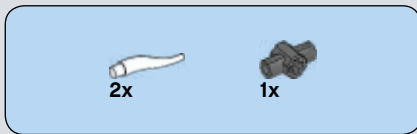
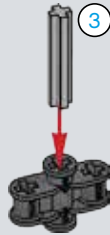
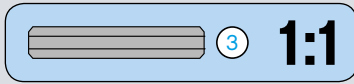

38

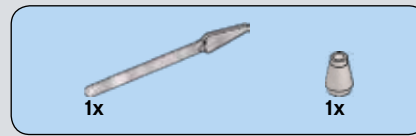
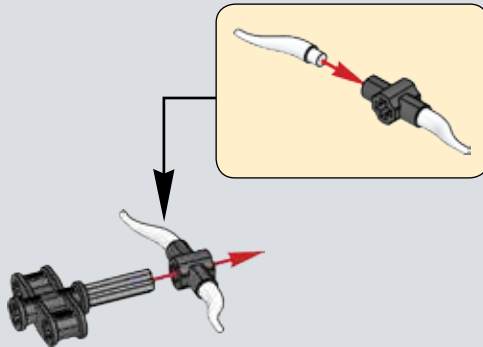
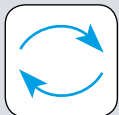

39

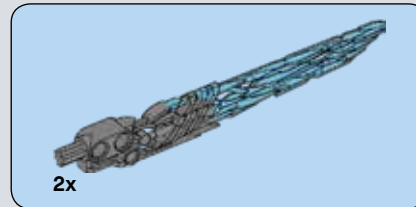
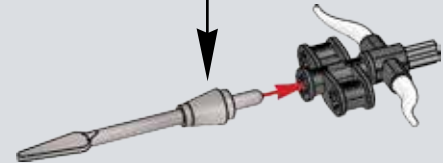
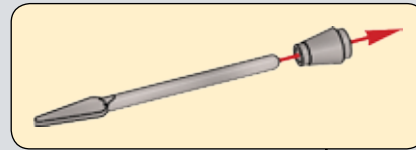

40

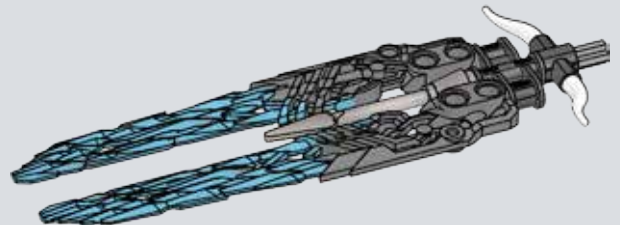

1x

4



4

1:1

41

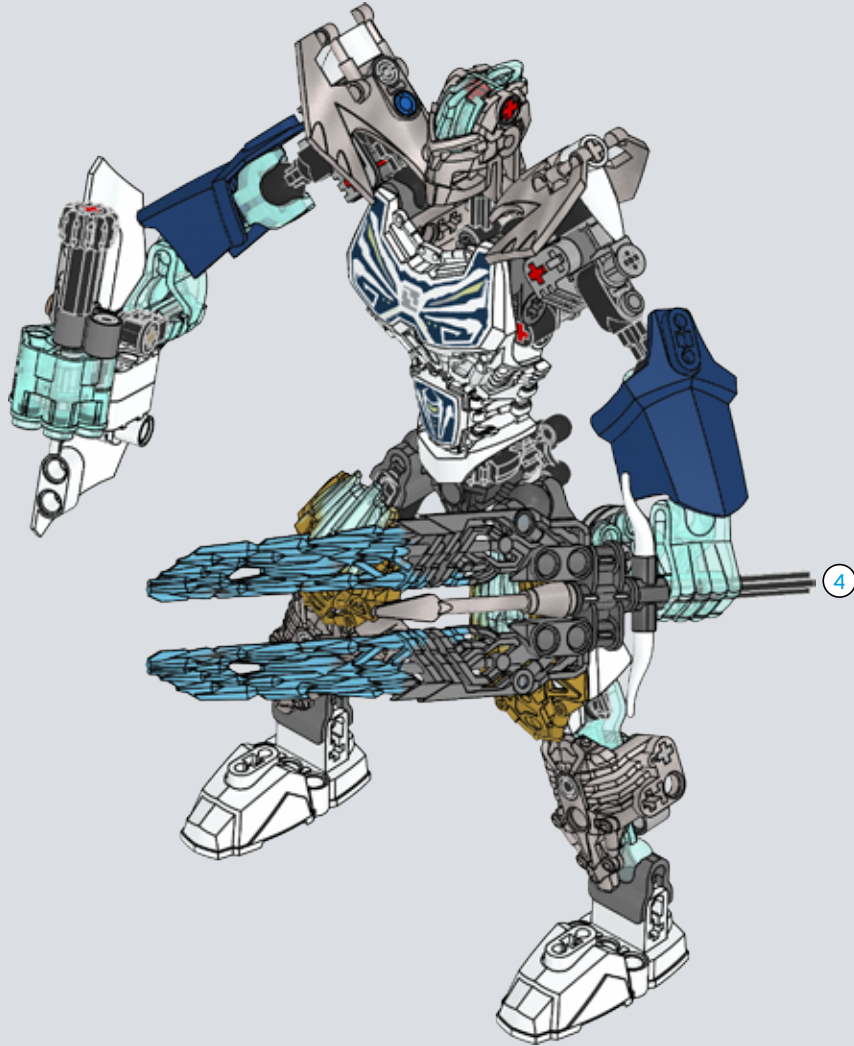

4

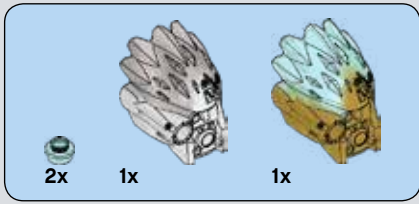

42

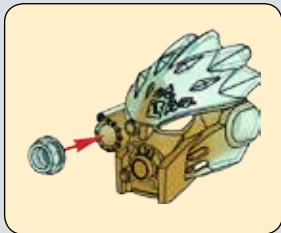
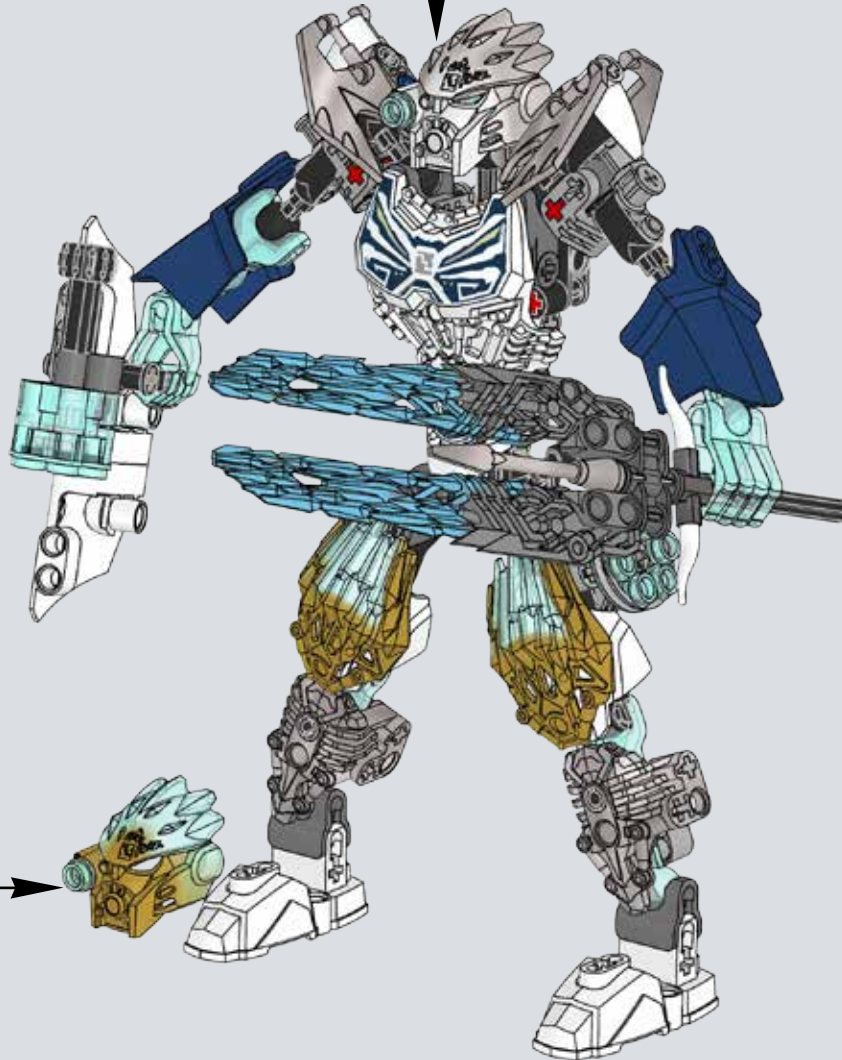
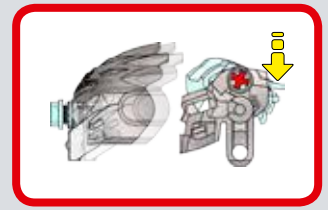
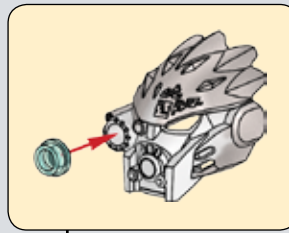

43

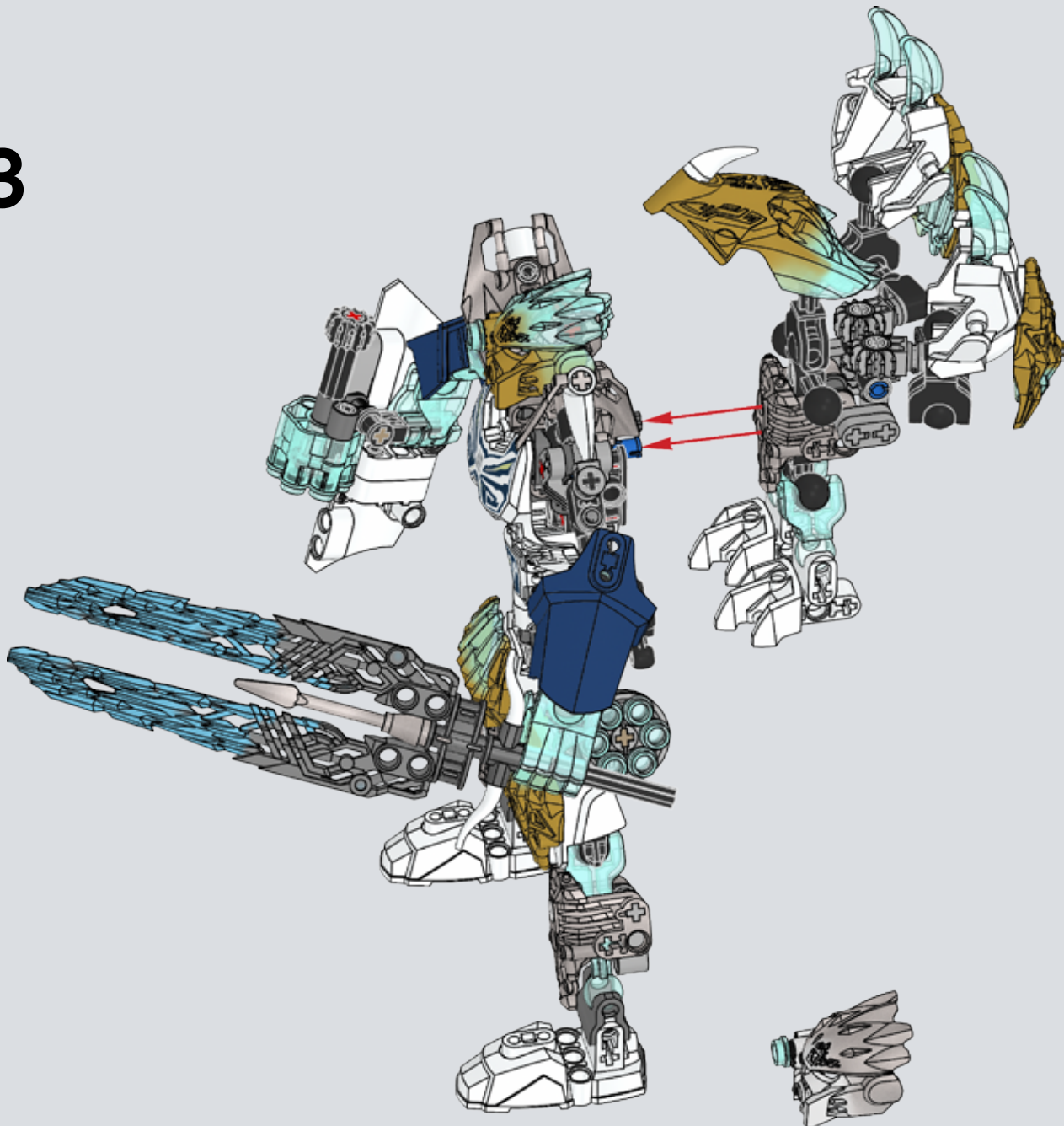

44

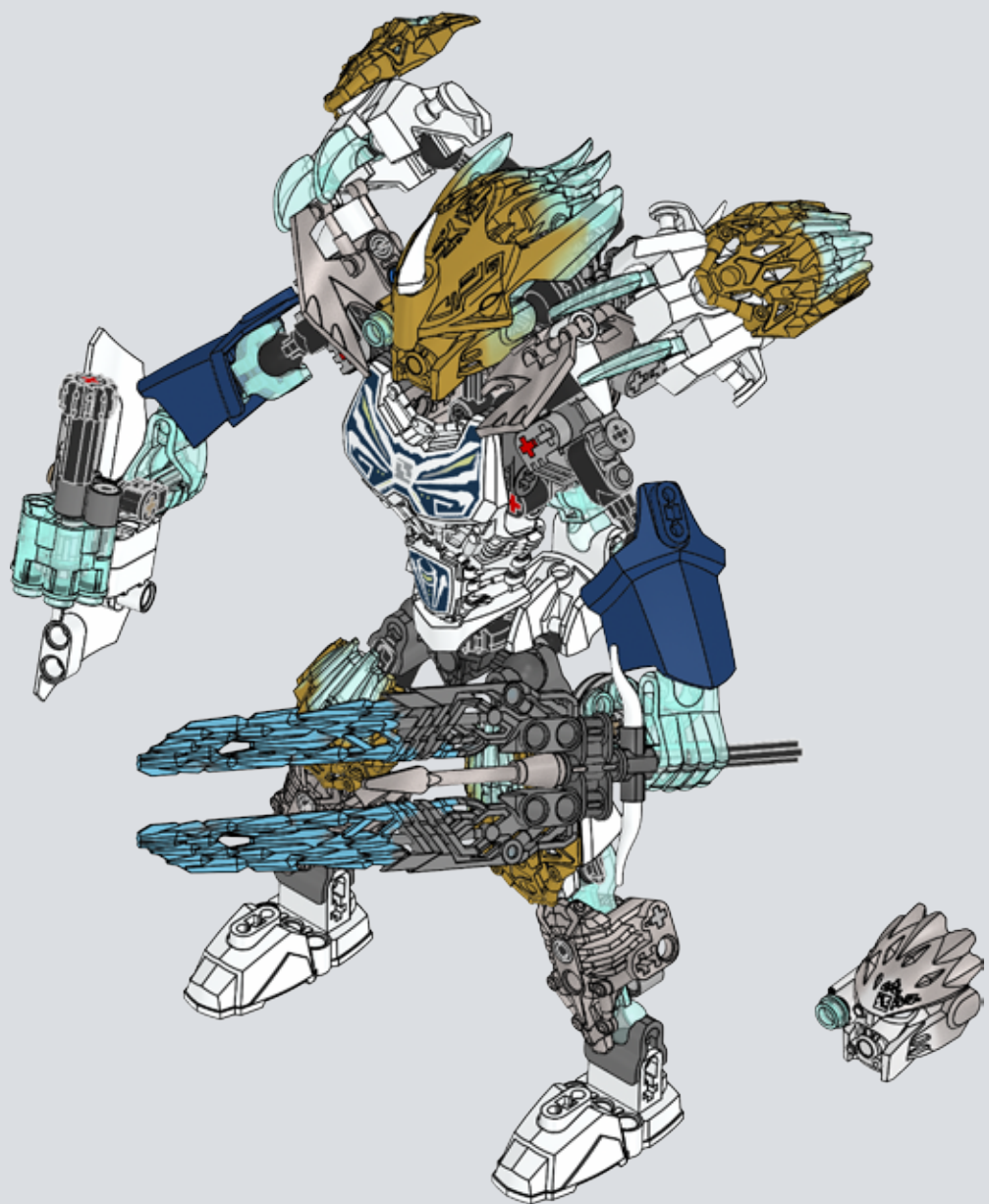



4x
4173941



2x
6032360



2x
4566256



1x
4558874



1x
4547581



2x
4632643



2x
6108814



2x
6014003



2x
4632583



1x
6143911



8x
4142865



4x
4514553



2x
4560174



2x
4177431



13x
4121715



1x
4512363



1x
4248204



4x
6089119



1x
4107765



2x
4121667



1x
370526



6x
4560108



3x
4609682



1x
4667277



1x
4667277



1x
4667277



1x
4667277



1x
6135125



2x
4593562



2x
6031821



2x
6135226



2x
6135226



14x
4163917



4x
6071312



1x
6135238



2x
6043677



1x
6100096



2x
6043685



1x
6135000



1x
6135000



2x
6043679



2x
6043680



4x
6135071



1x
6135049



2x
6150659



1x
6150659



2x
6150659



2x
6150659



3x
4211573



2x
4211483



3x
6134848



4x
4211741



1x
6097090



2x
6123815



2x
4211553



3x
4630114



1x
4494222



4x
4211779



5x
4211815



1x
4211639



1x
4210655



4x
6106472



1x
6015356



1x
6015356



2x
4626667



2x
6083620



4x
4210851



1x
6121350



1x
6102606



2x
6016585



4x
6135237



1x
6139106



1x
6139106



1x
6139106



1x
6139106



1x
6139106



1x
6139106



2x
6022718



1x
6139106



1x
6139106



Customer Service
Kundenservice
Service Consommateurs
Servicio Al Consumidor
LEGO.com/service or dial

00800 5346 5555 :
1-800-422-5346 :



BIONICLE®

71310



UNITE for battle



LEGO.com/bionicle

71311



Download on the
App Store

Apple, the Apple logo, iPad, iPhone and iPod touch are trademarks of Apple Inc. Apple, le logo Apple, iPad, iPhone et iPod touch sont des marques de commerce d'Apple Inc. Apple, el logotipo de Apple, iPad, iPhone e iPod touch son marcas comerciales de Apple Inc.

Download App
Télécharger
l'application
Descarga la App



GET IT ON
Google play

Google Play is a trademark of Google Inc. Google Play est une marque de commerce de Google Inc. Google Play es una marca comercial de Google Inc.

NETFLIX



UNIS-LES pour le combat • Sólo podemos luchar UNIDOS



71300

71305



71303

71308



71301

71306



71304

71309



71302

71307



71311

71311



71311

71302

71301

71311

71307

71306



71303

71304

71300

71308

71305

71309

WIN

GO TO WWW.LEGO.COM/PRODUCTFEEDBACK AND
GIVE US YOUR SHORT **FEEDBACK** ABOUT THIS
LEGO® SET FOR A CHANCE TO WIN
A COOL LEGO PRIZE.



LEGO.com/productfeedback

GEWINNE



Erzähle uns auf
www.LEGO.com/productfeedback

*etwas über die Erfahrungen, die du mit
diesem LEGO® Set gemacht hast, und
sichere dir die Chance auf einen coolen
LEGO Preis!*

GAGNE



Rends-toi sur
www.LEGO.com/productfeedback

*et donne-nous quelques commentaires
sur ce produit LEGO® pour avoir une
chance de gagner un prix LEGO !*

GANA



Visita
www.LEGO.com/productfeedback

*y envíanos tu opinión acerca de este set
LEGO®. ¡Participarás en el sorteo de un
premio LEGO!*

获取奖品



登录
www.LEGO.com/productfeedback

*给出关于此乐高®套装的简短反馈，
就有机会获得炫酷乐高奖品*