

BIONICLE

MANAS

9+



LEGO **TECHNIC**

8539



1



2



3

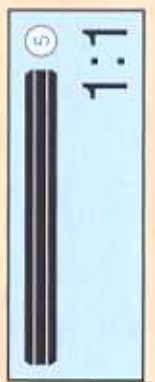
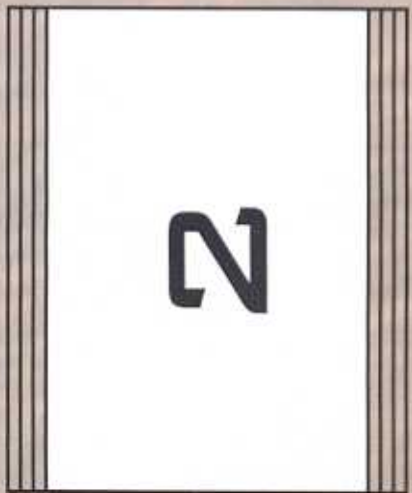
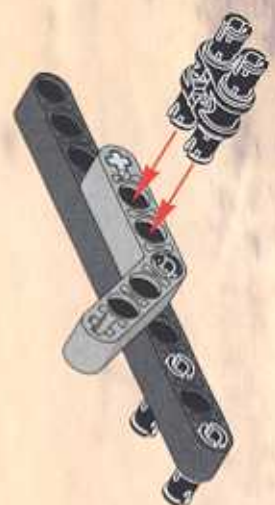



5

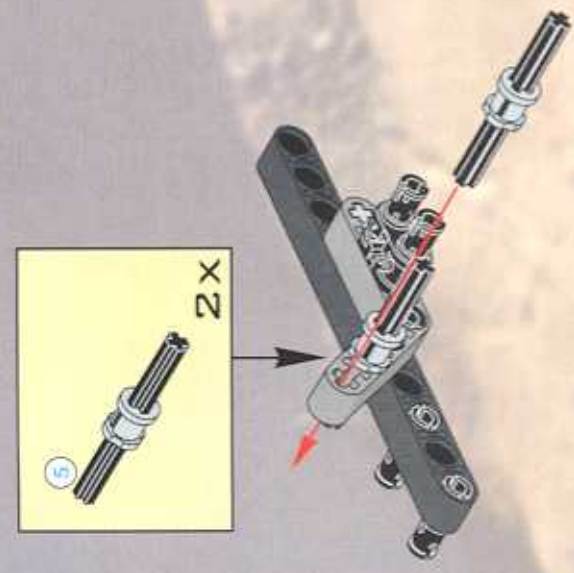

4



6



7

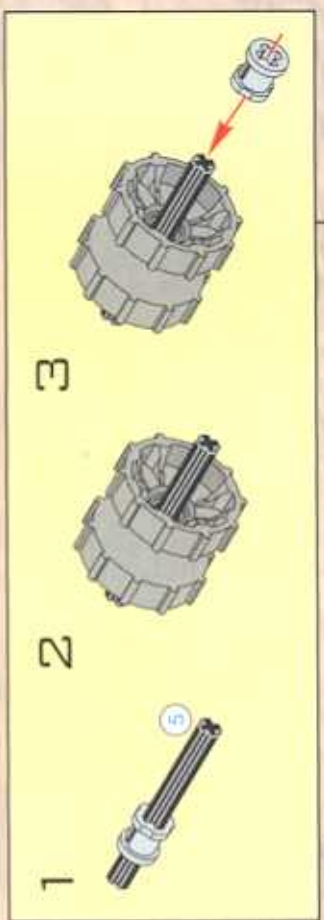



8

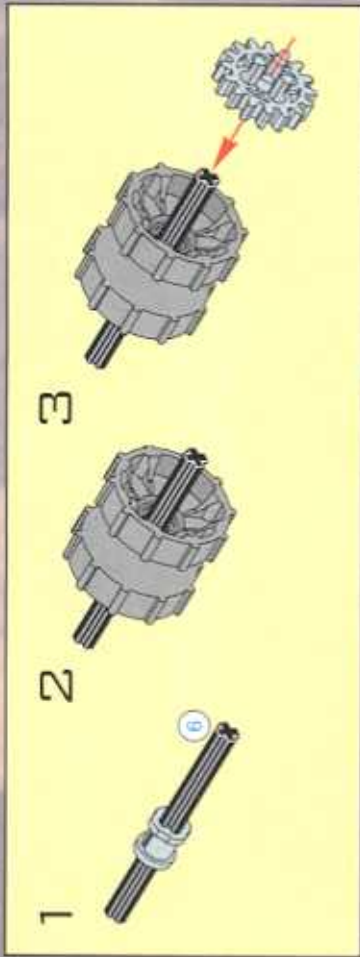

9

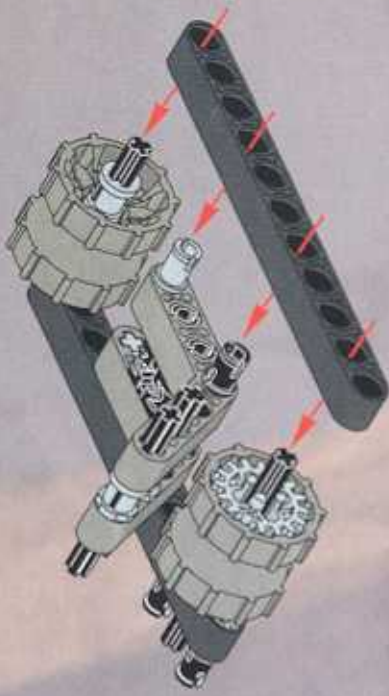

10

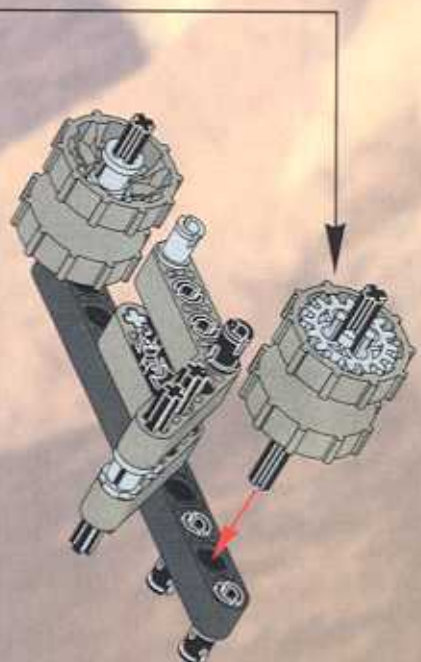
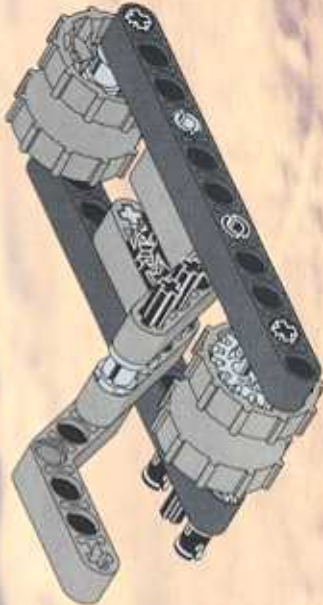

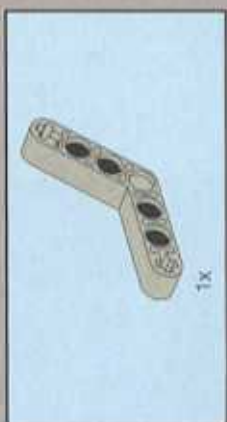
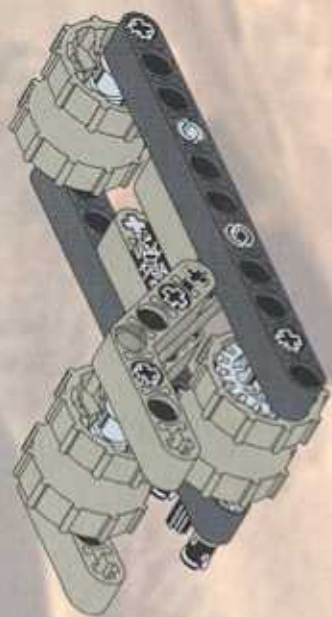

12



13



1:1



11

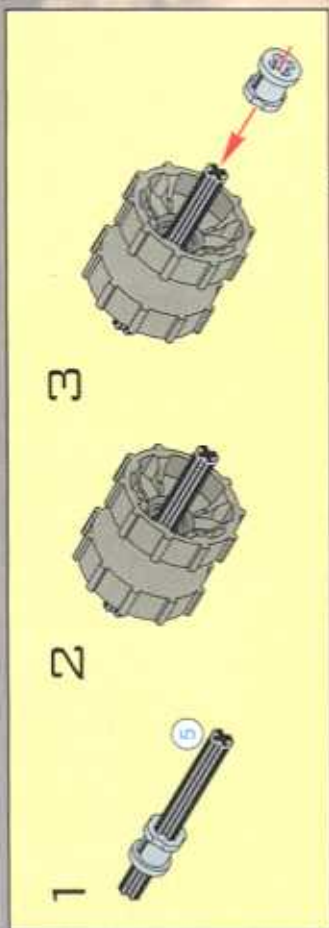

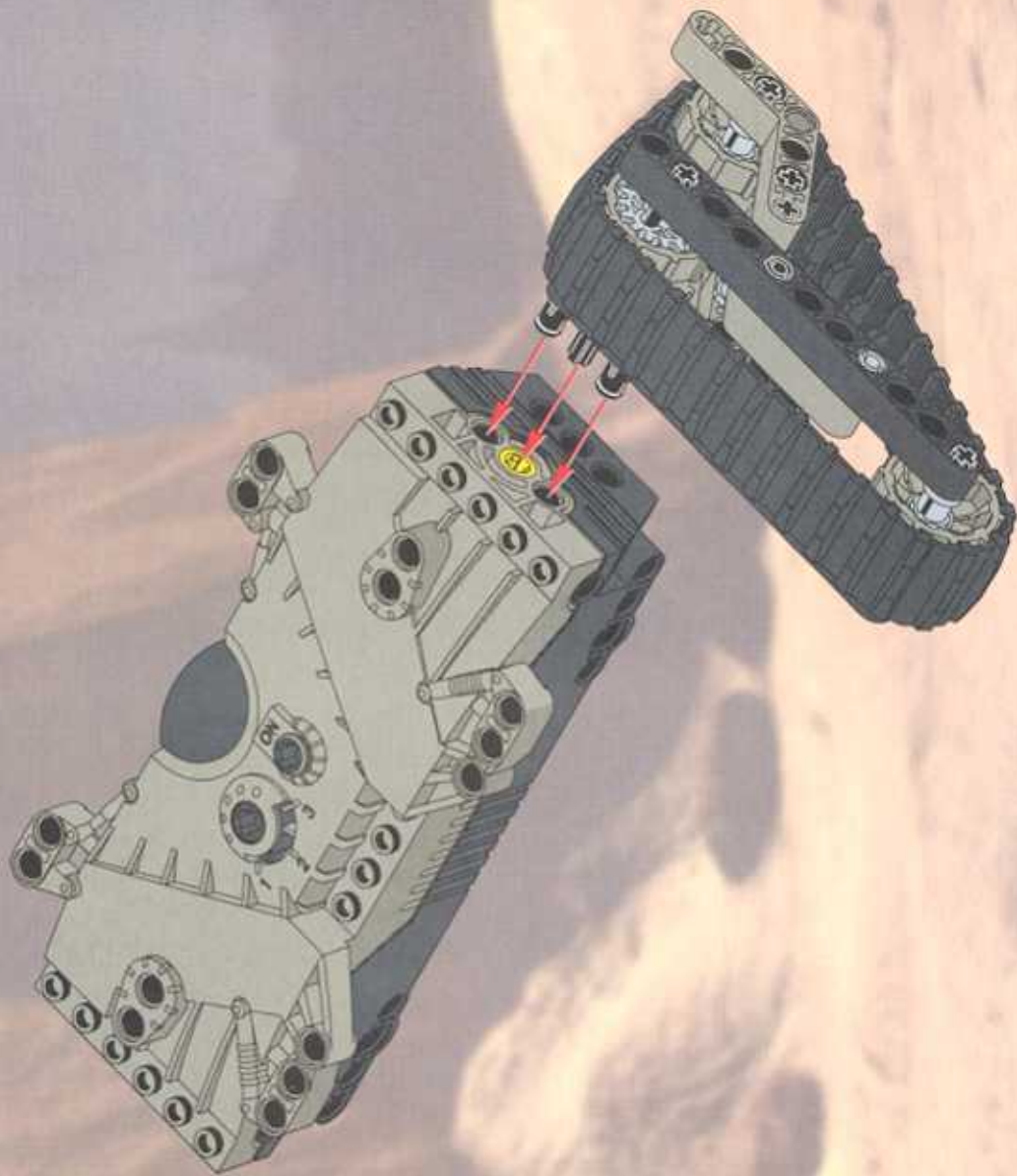

14

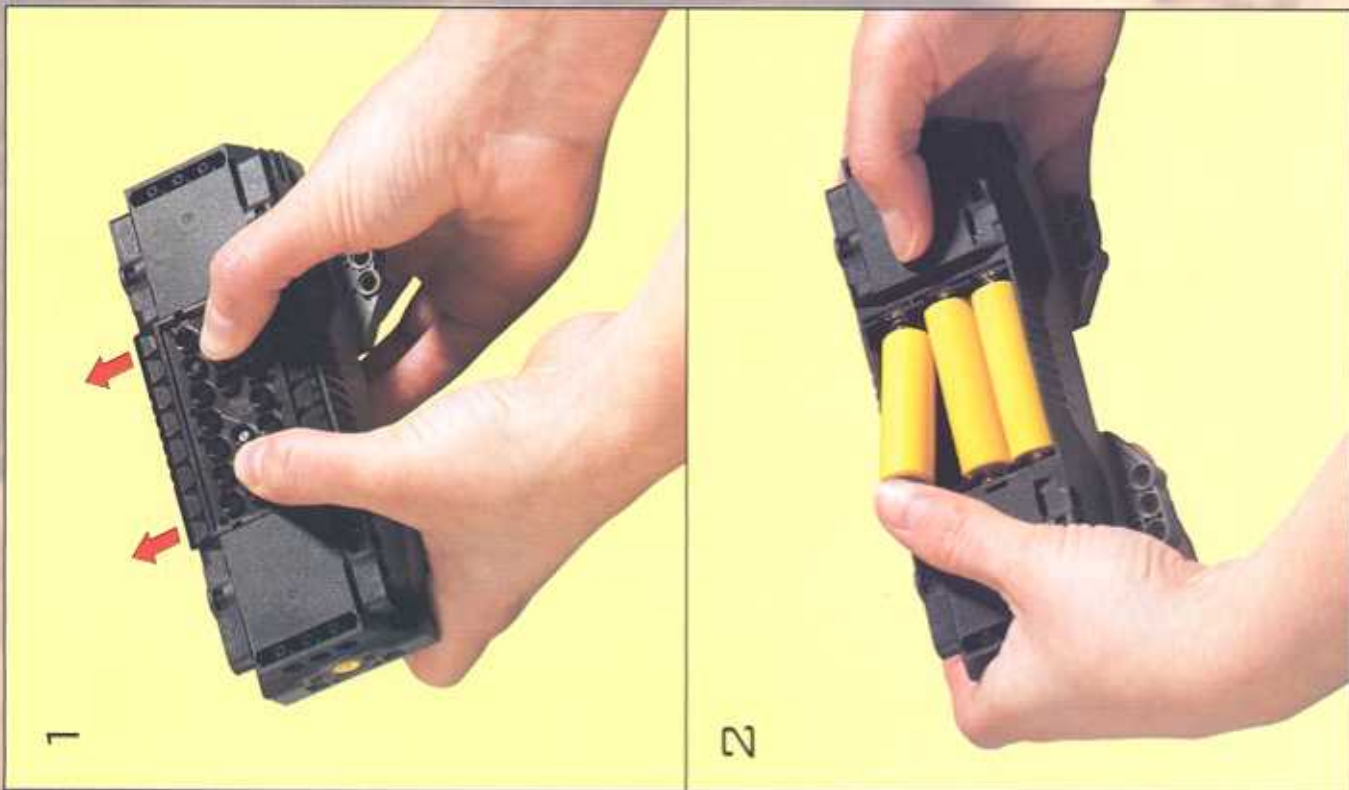

1

2





15

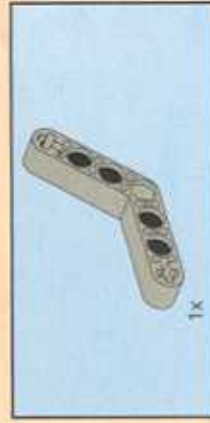

16



17

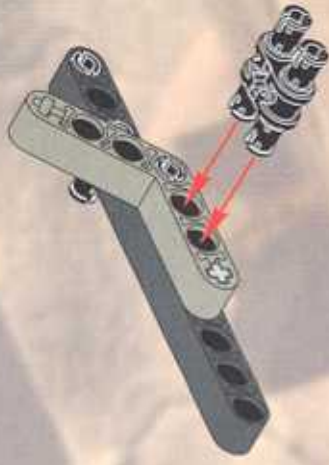

18





19



20

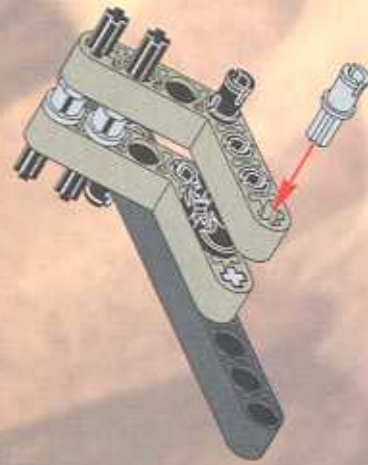

21

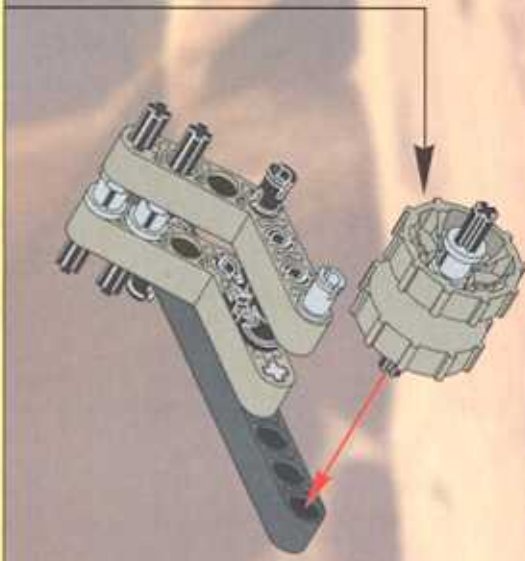
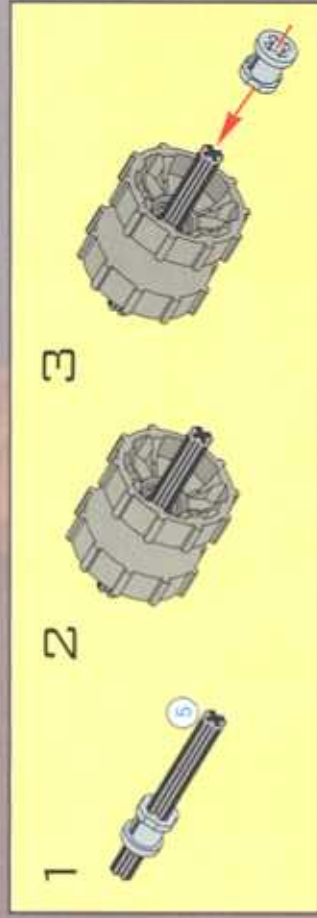

6
1:1

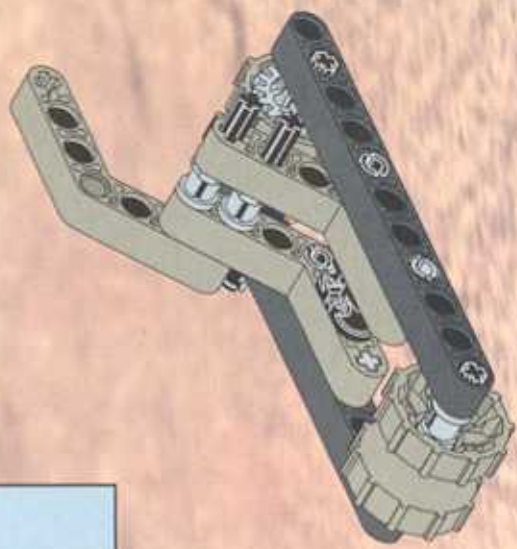
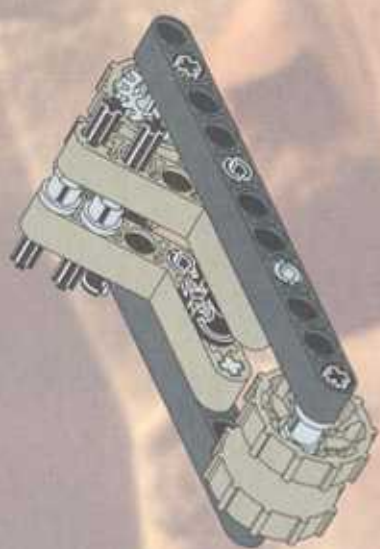

23

24

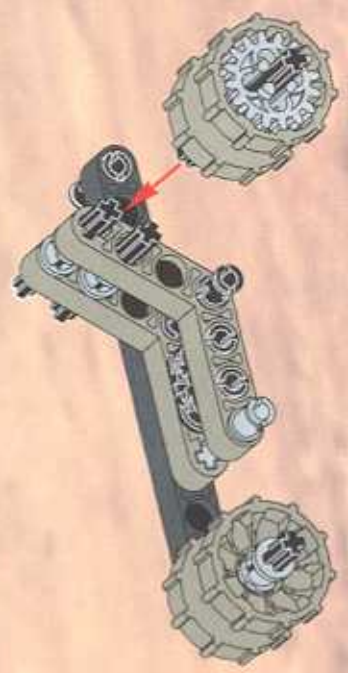
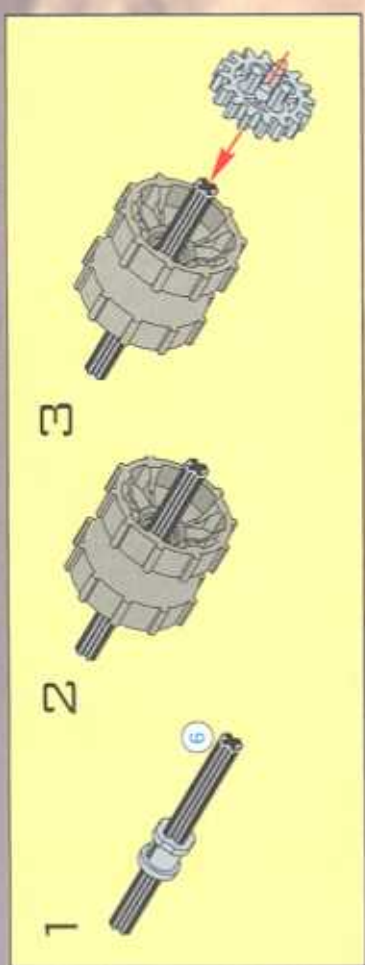

22

3

2

1

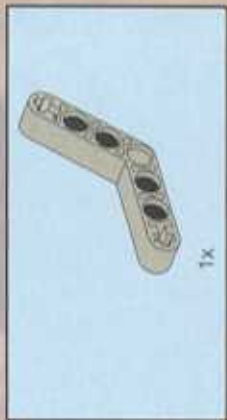

26

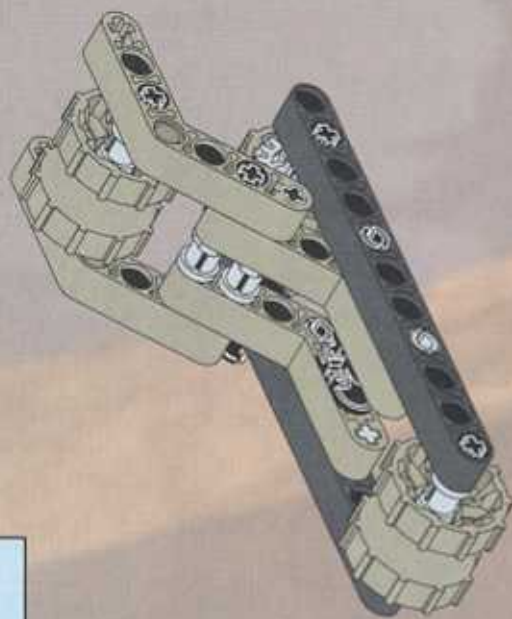

27



25

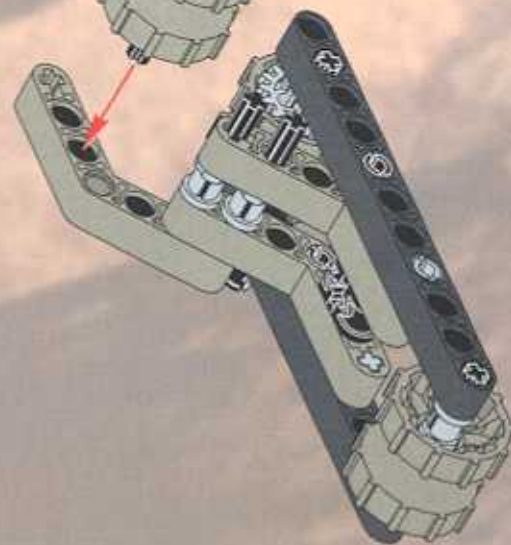
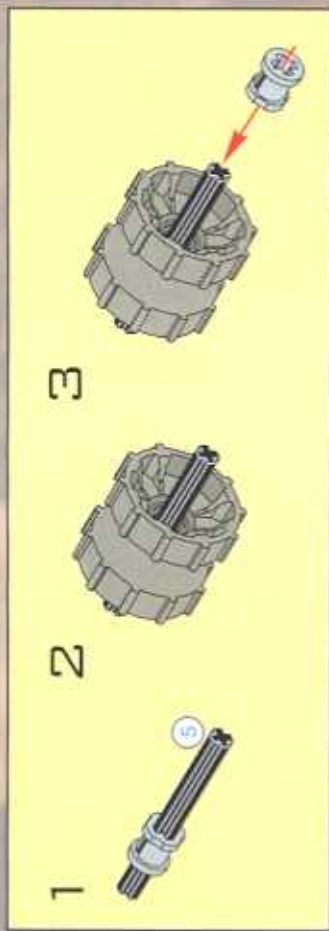

10

1:1

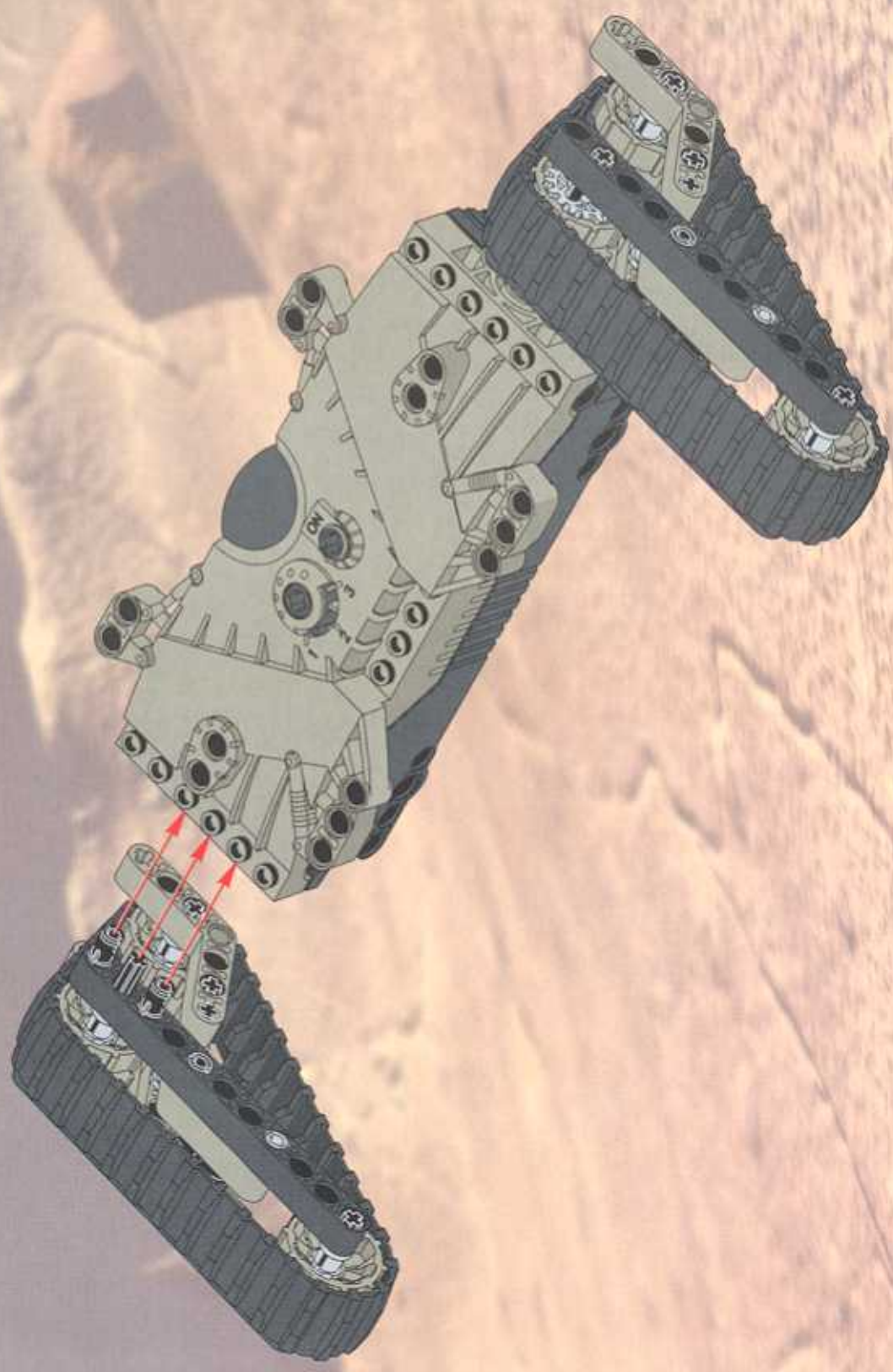

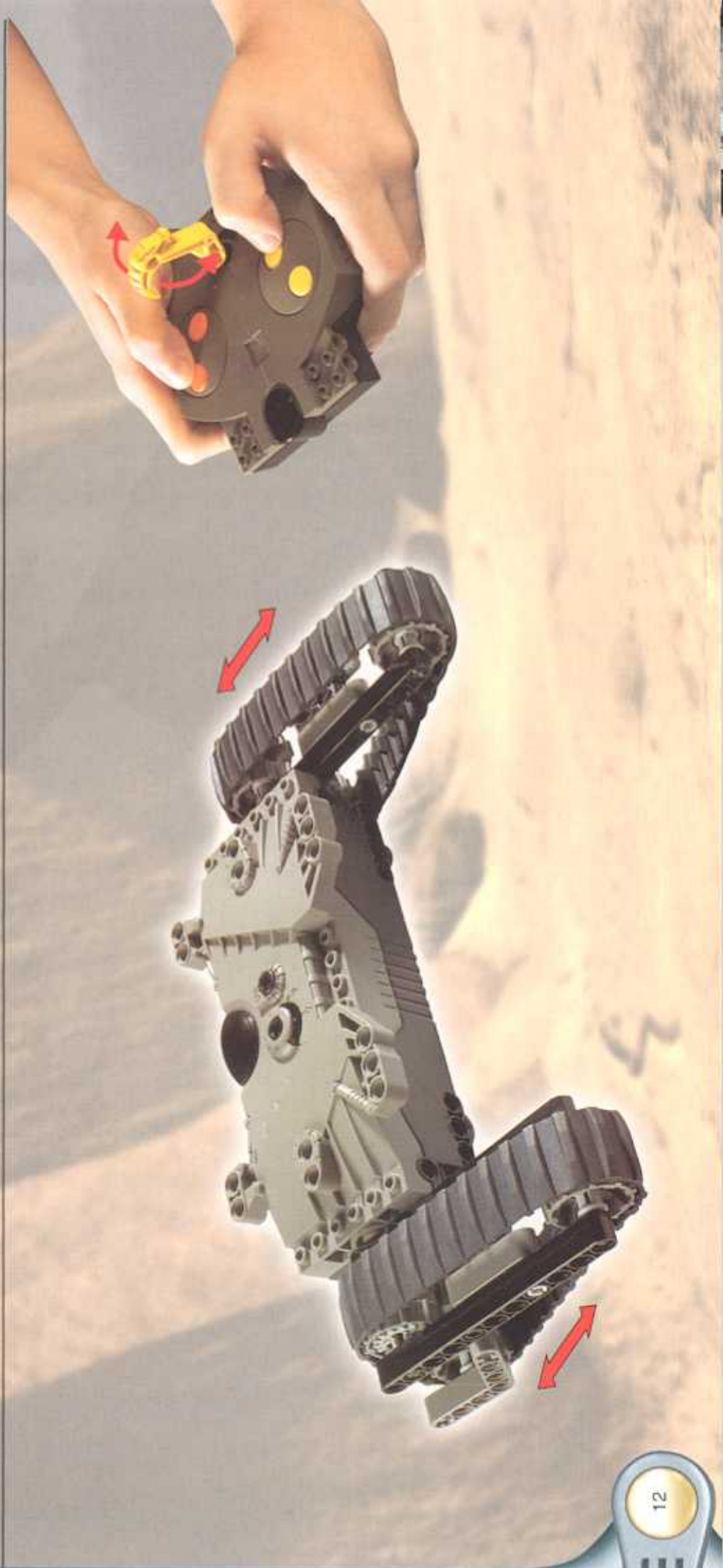
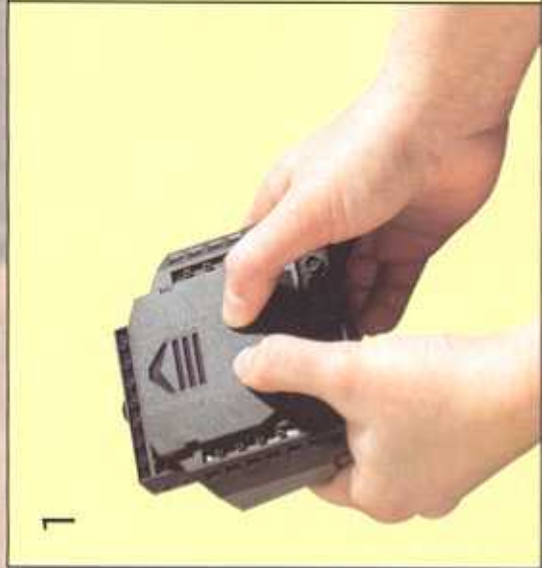
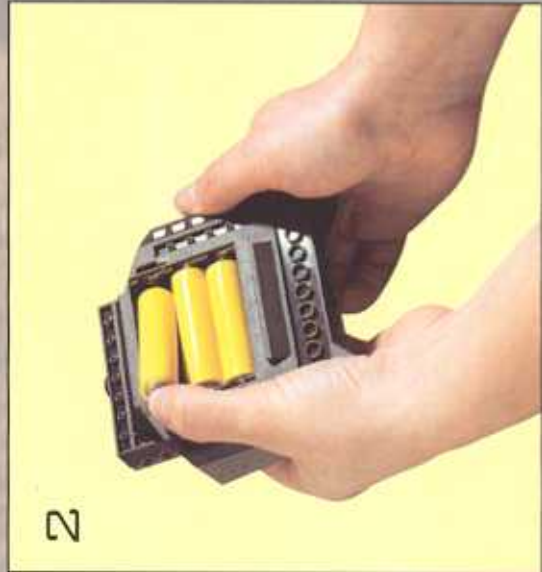



29

2x

2x

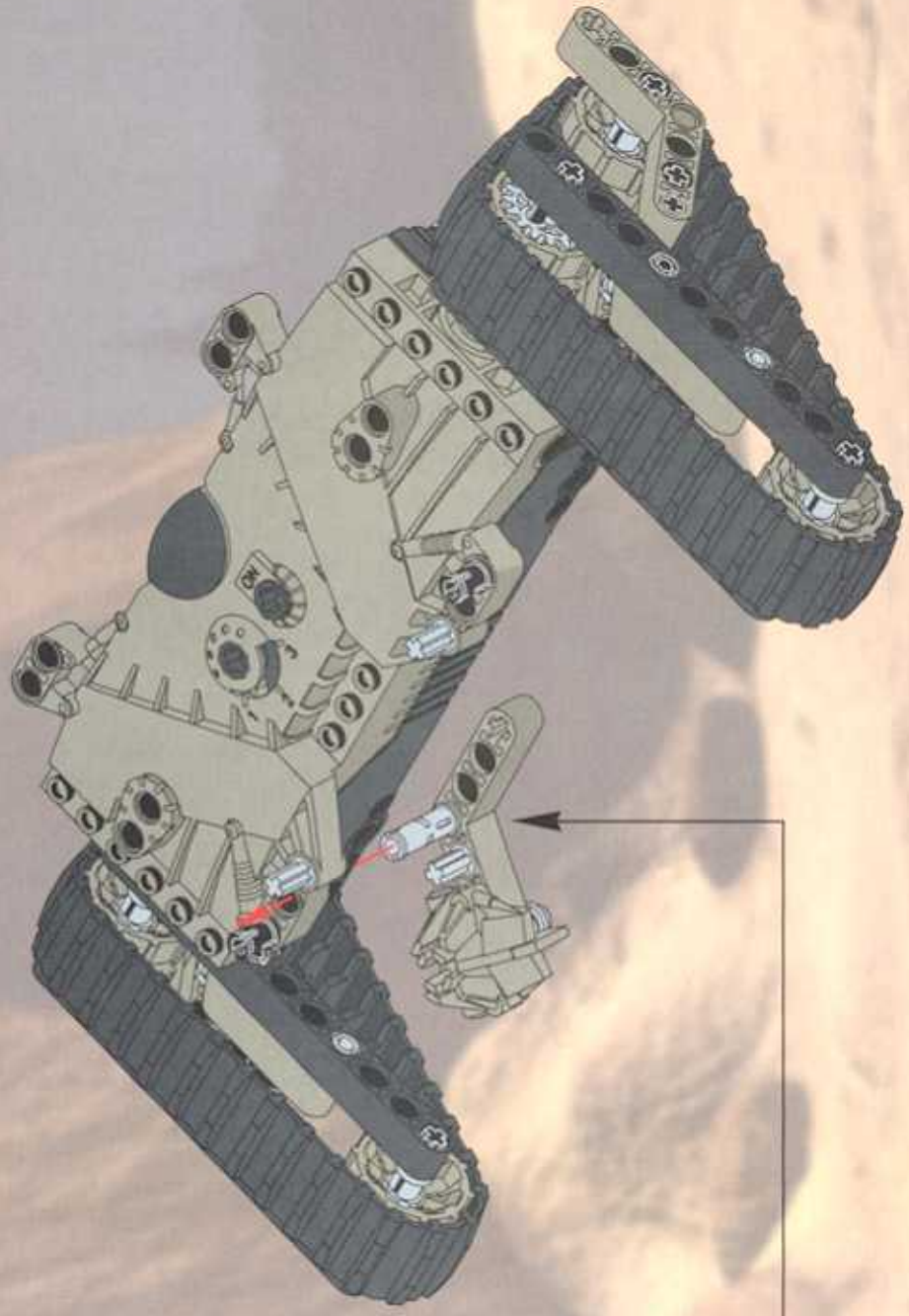

30

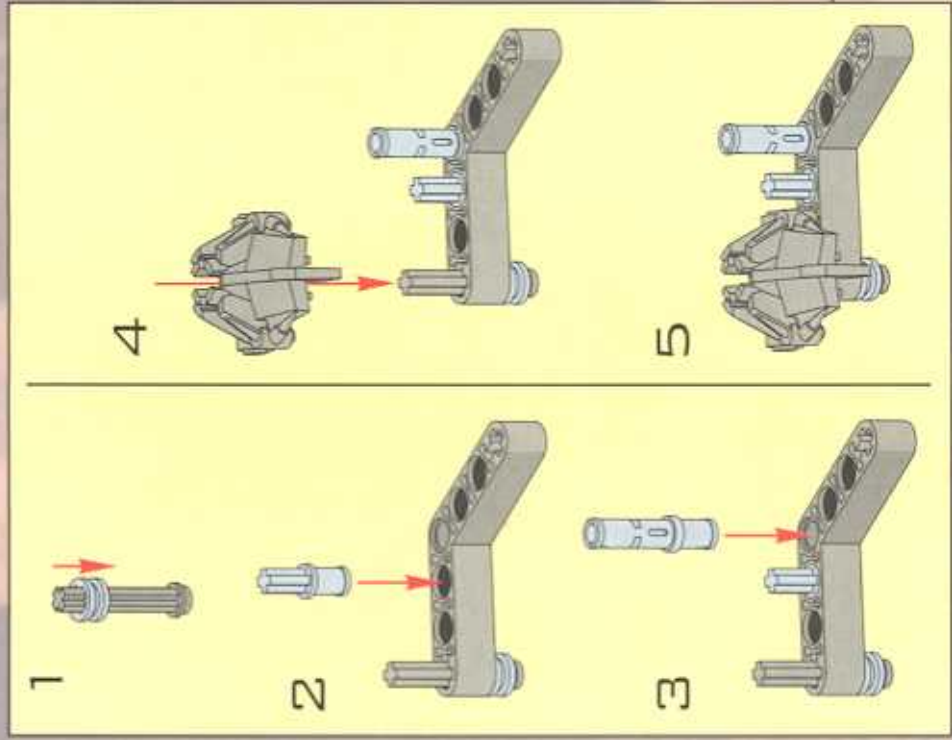

3

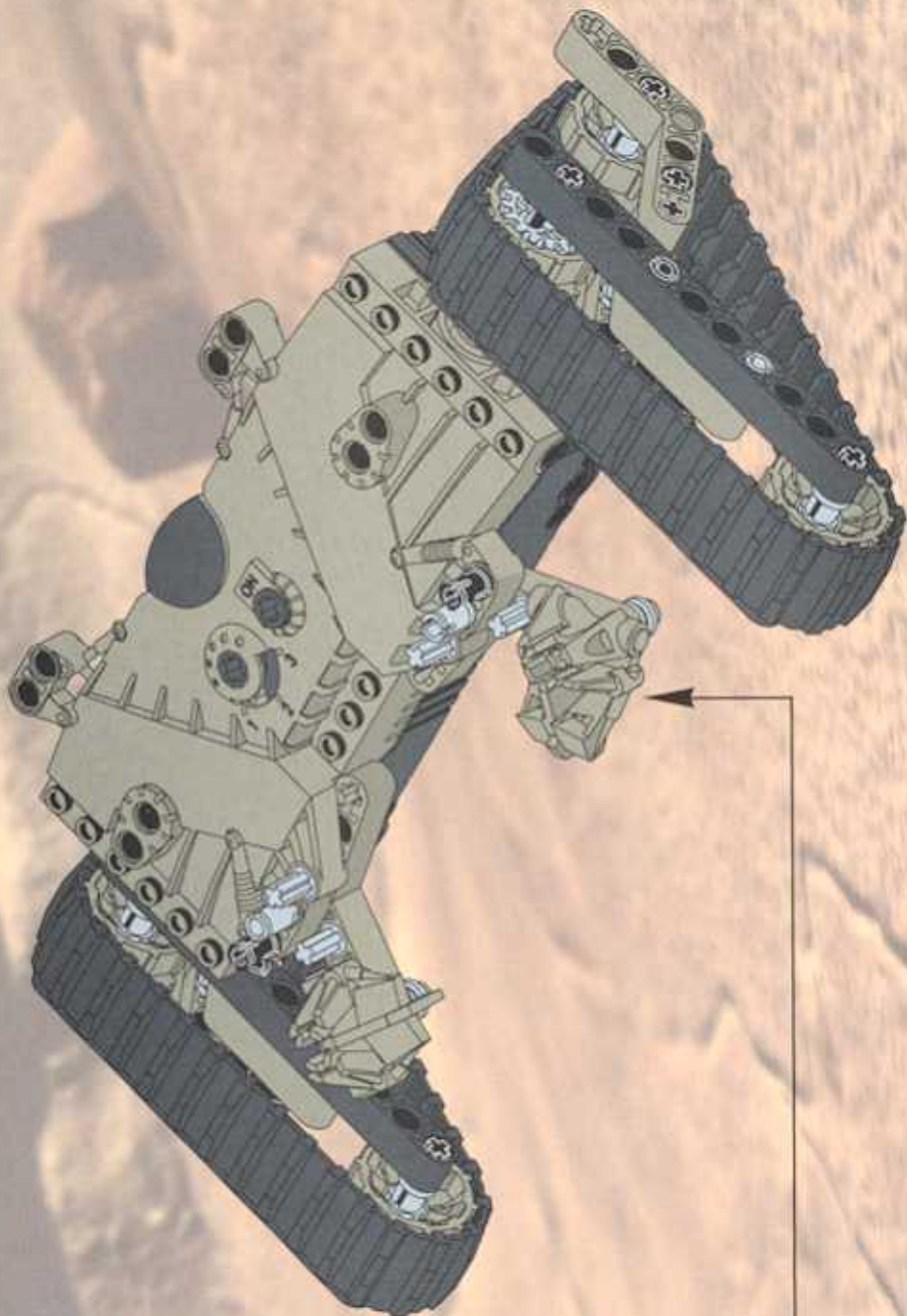

31

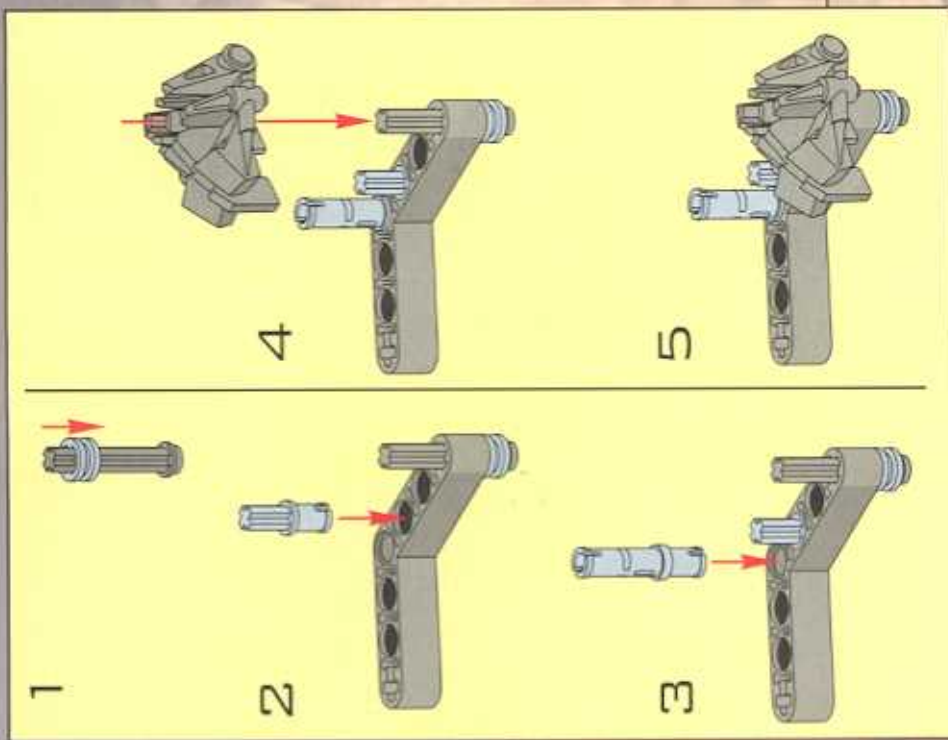

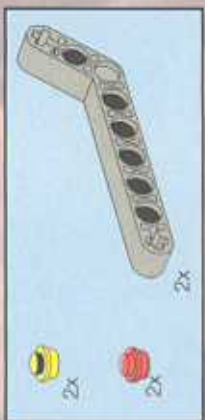
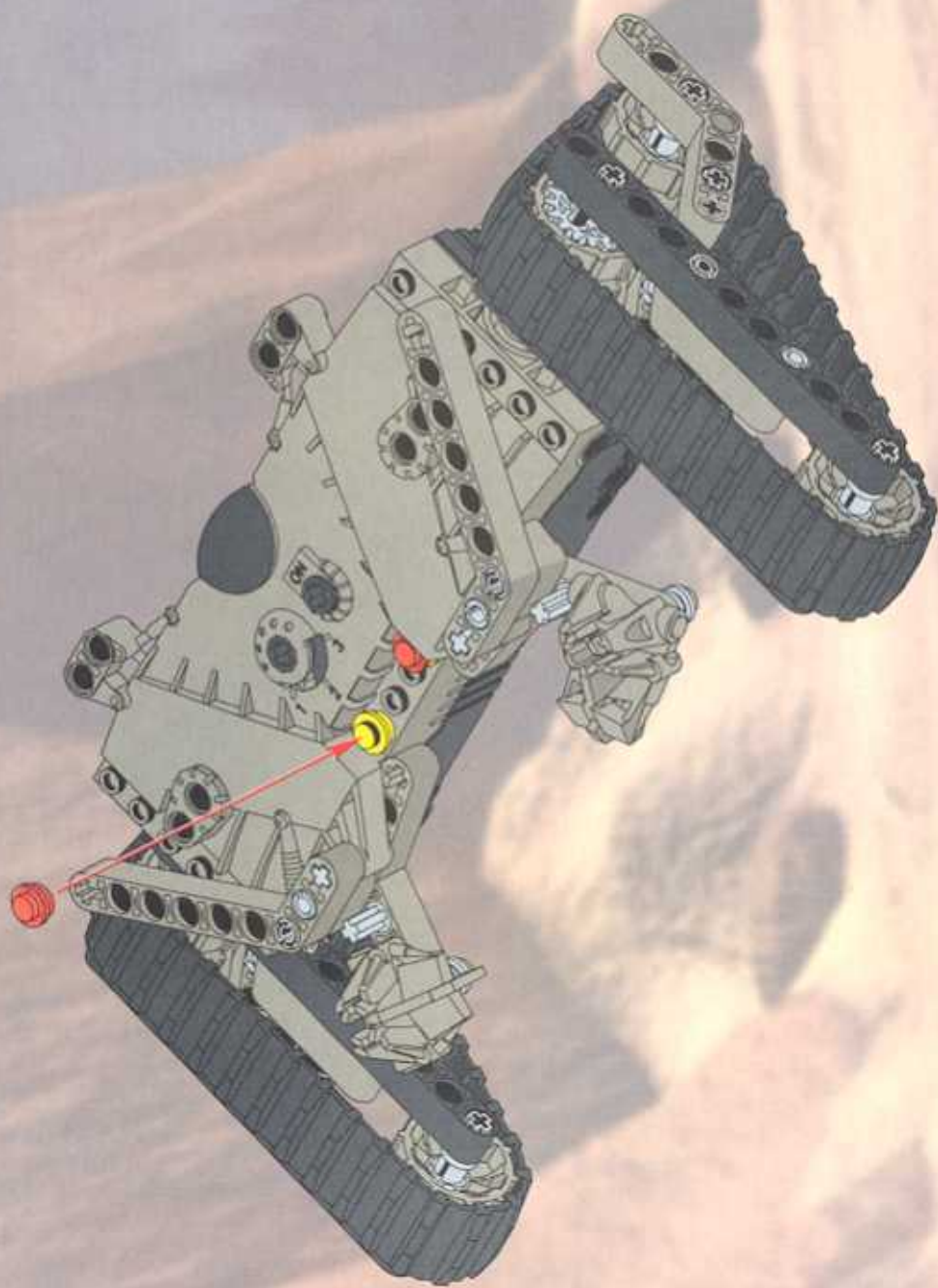

32

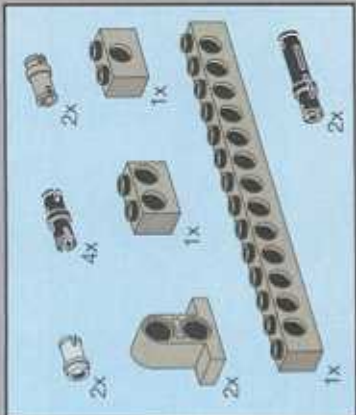
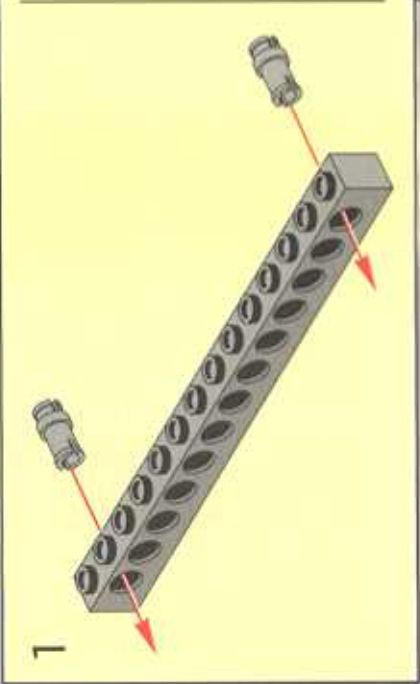
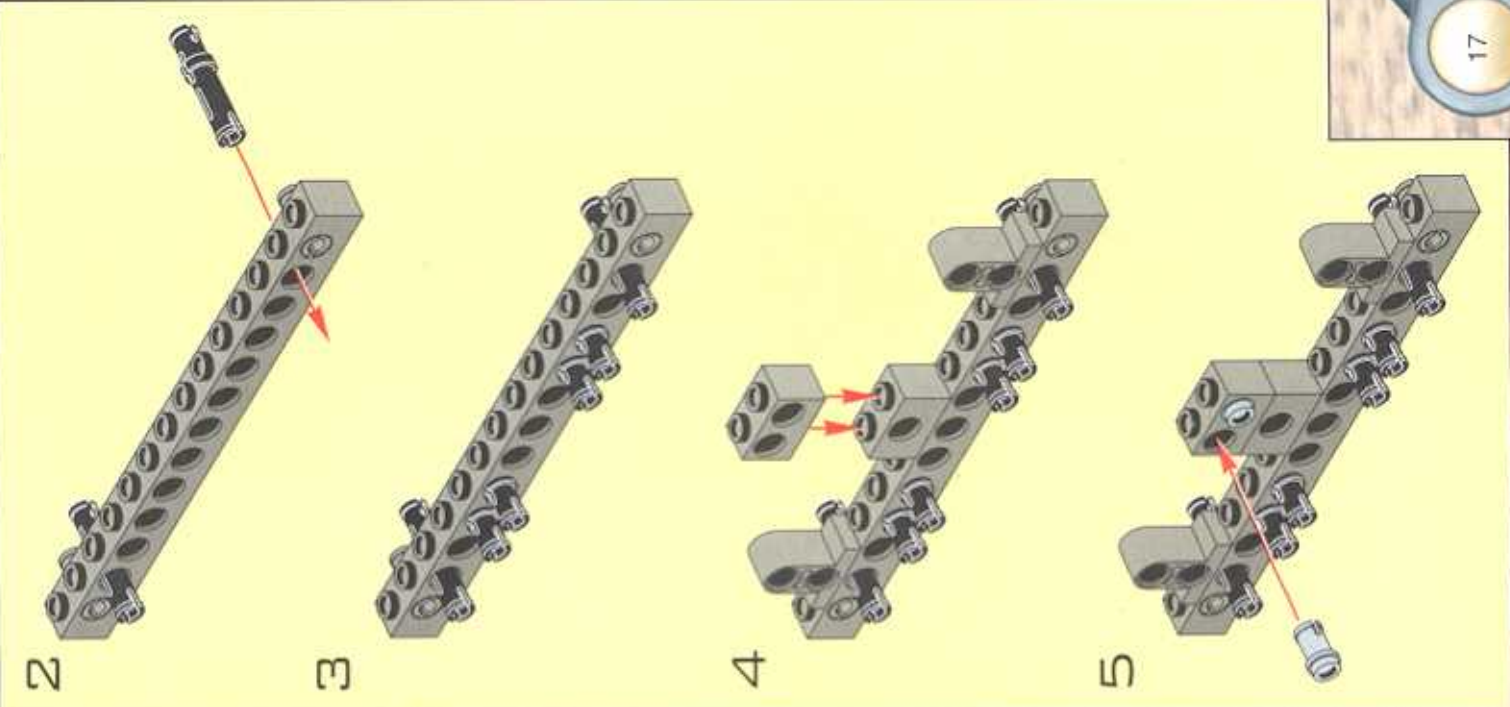

33

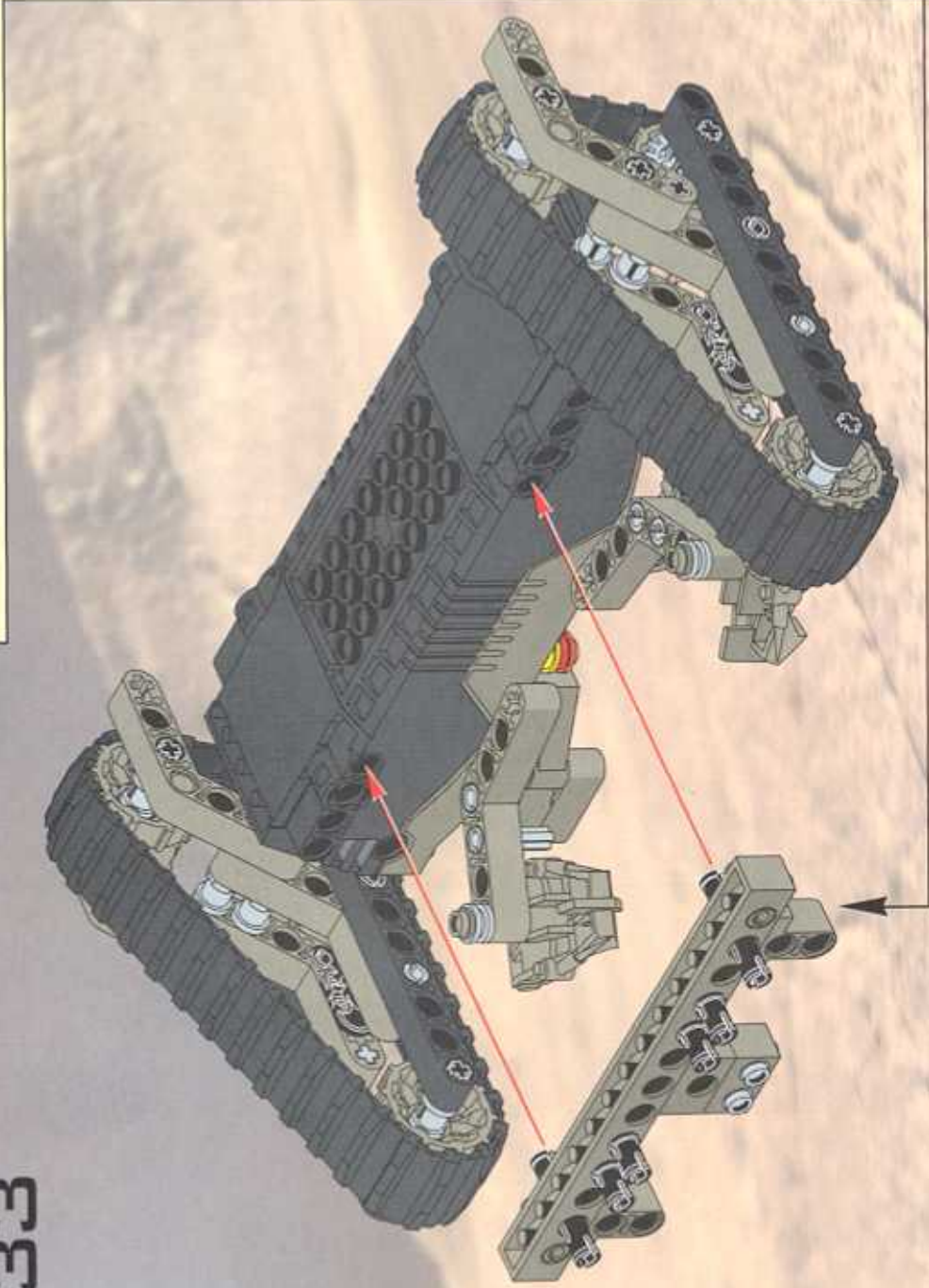



34

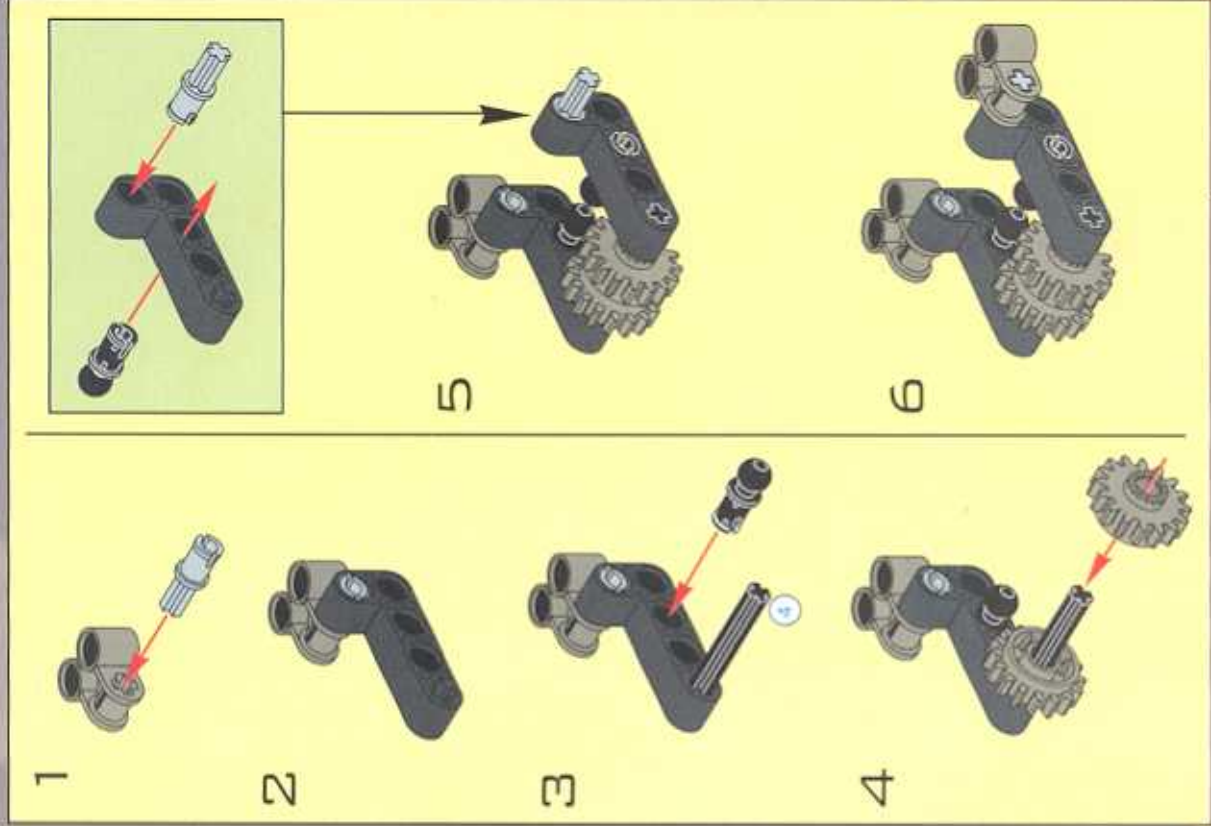
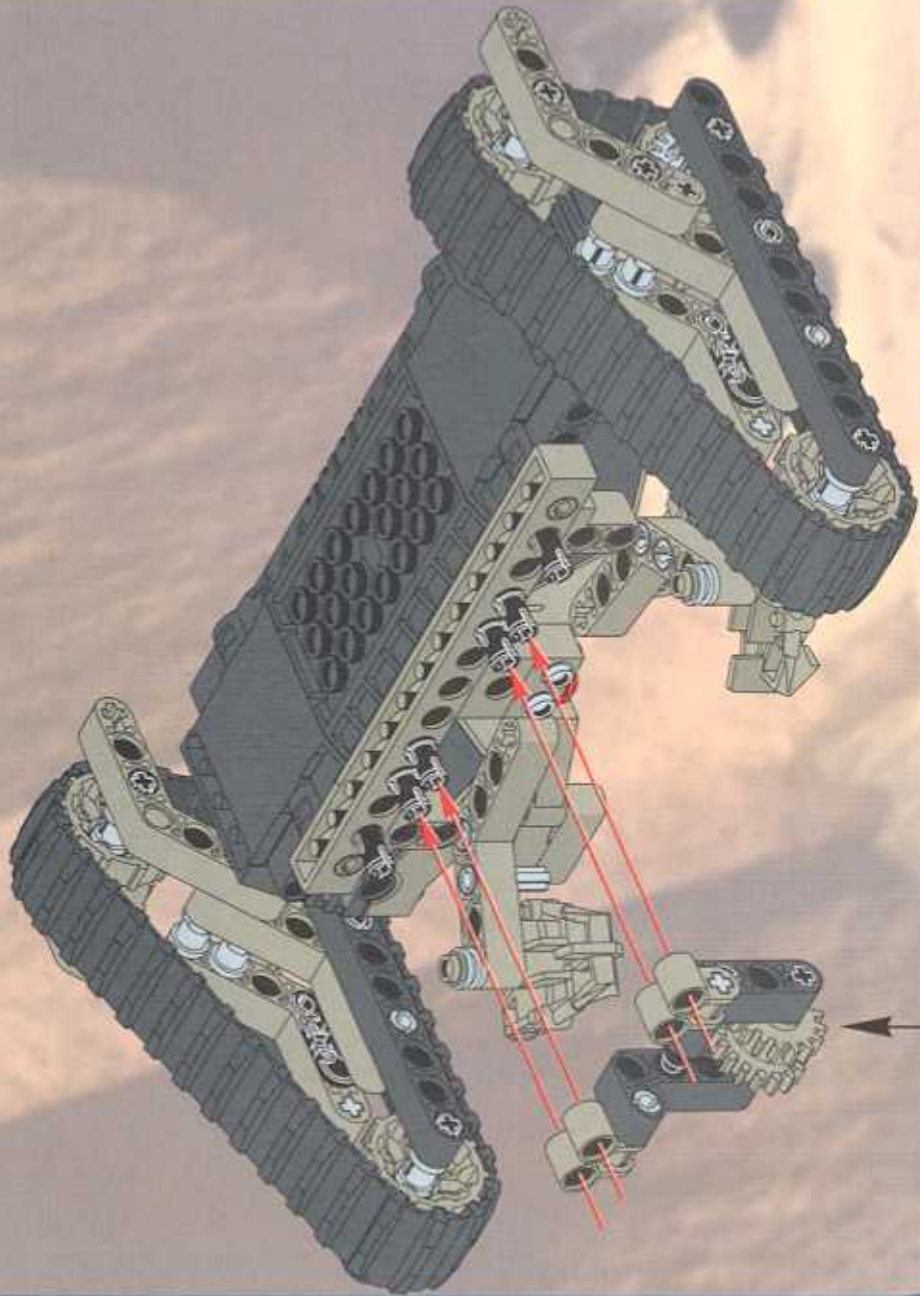

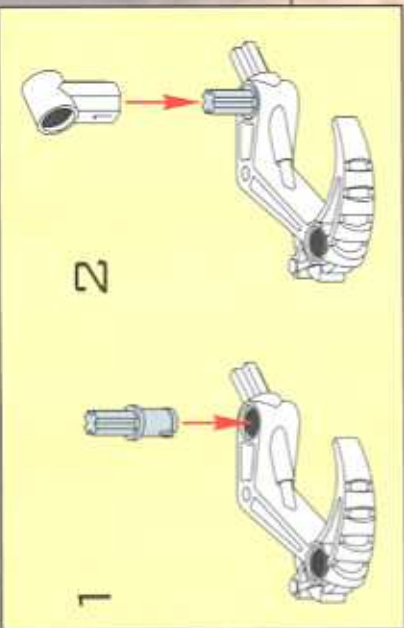
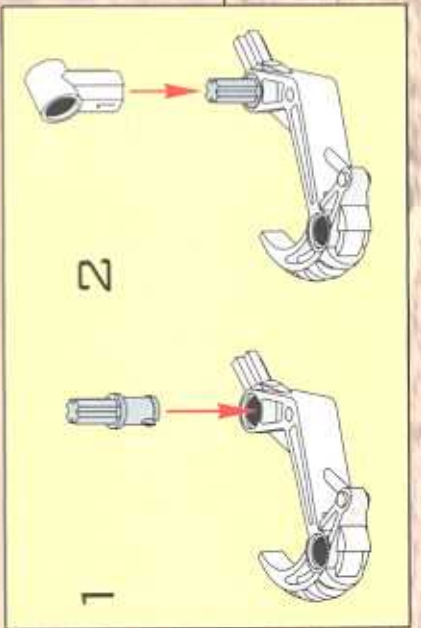
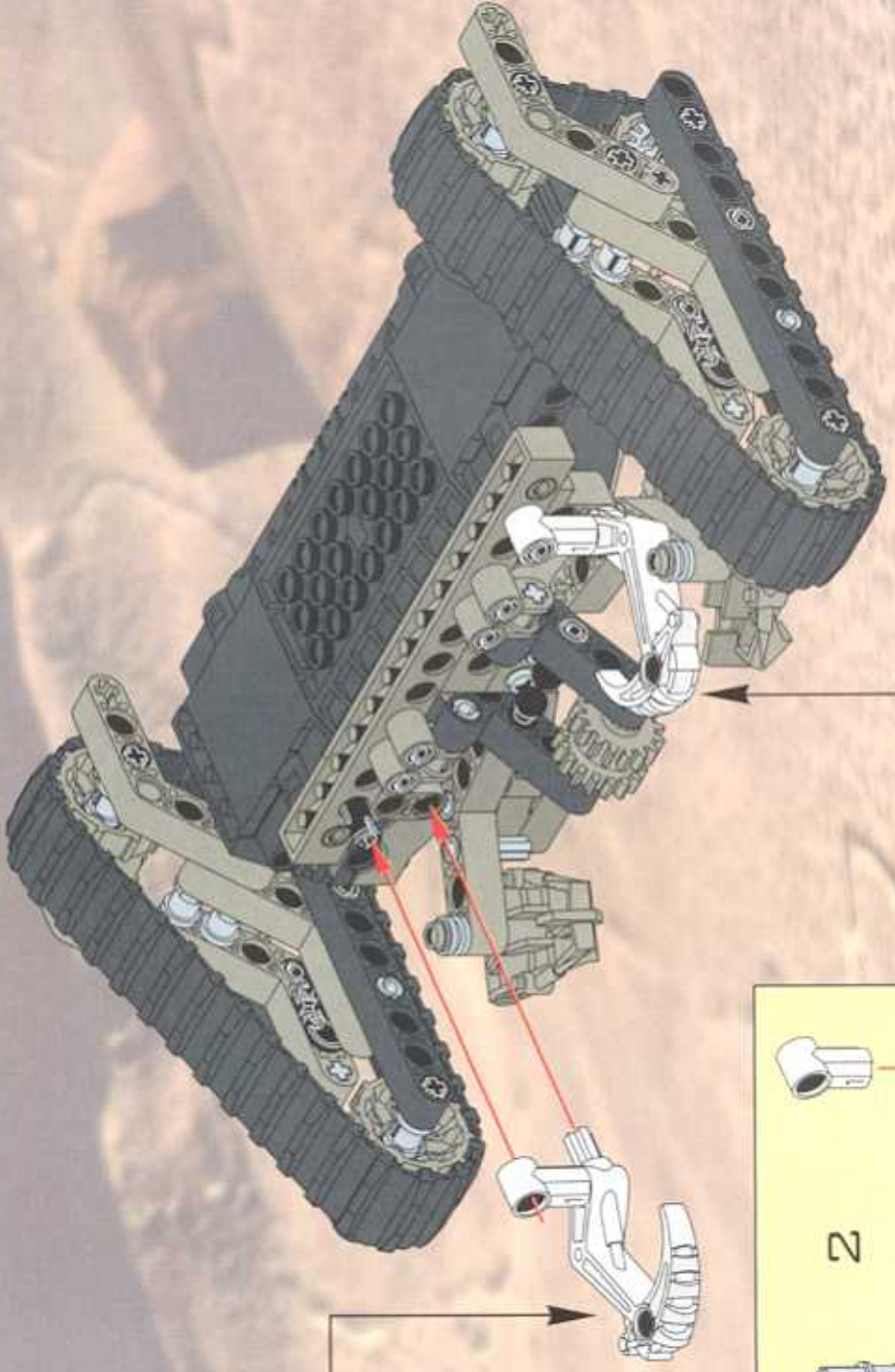

35



36

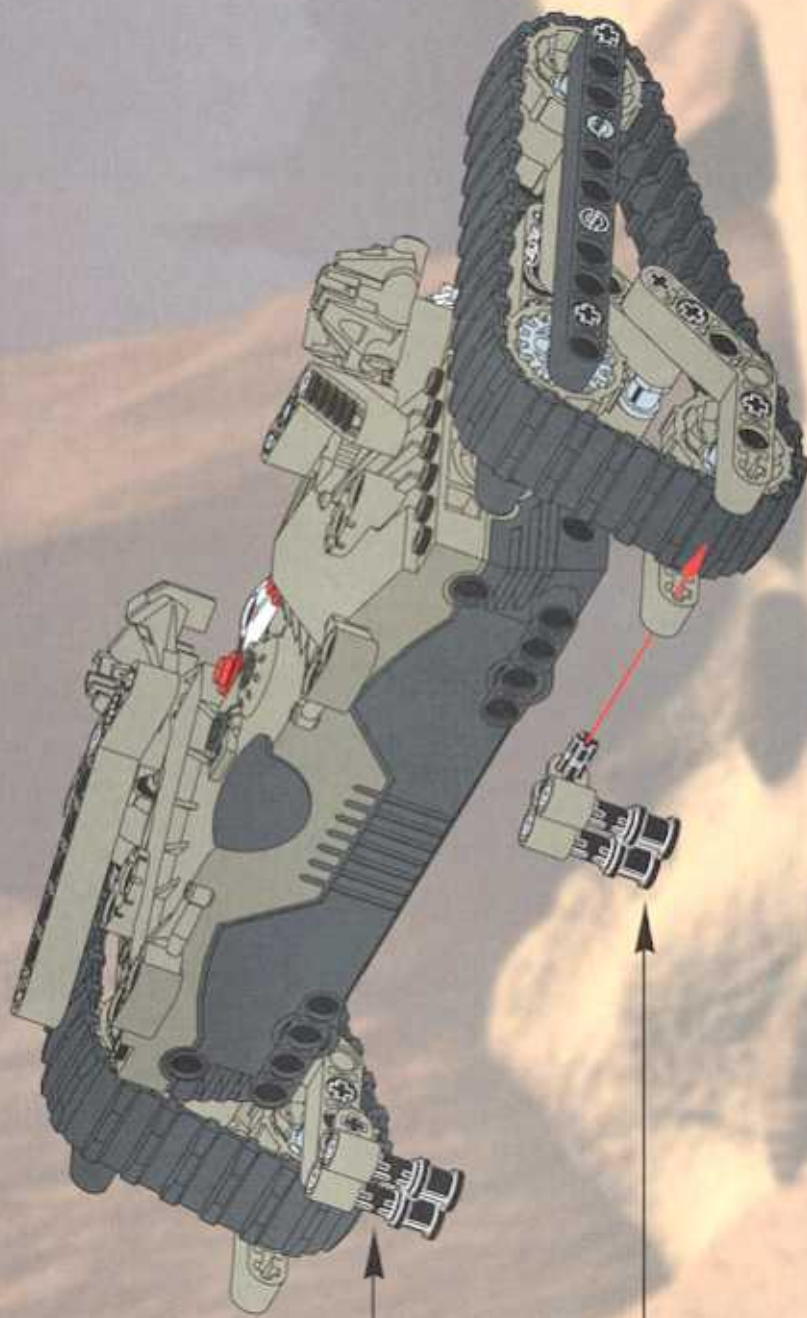
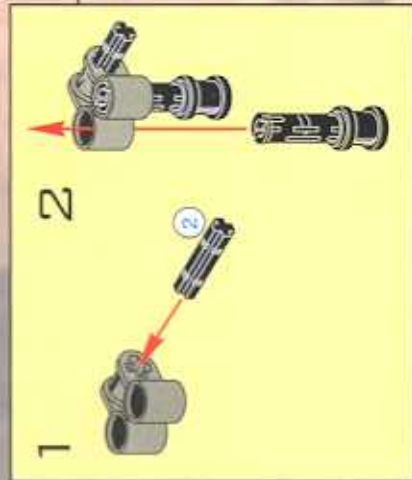
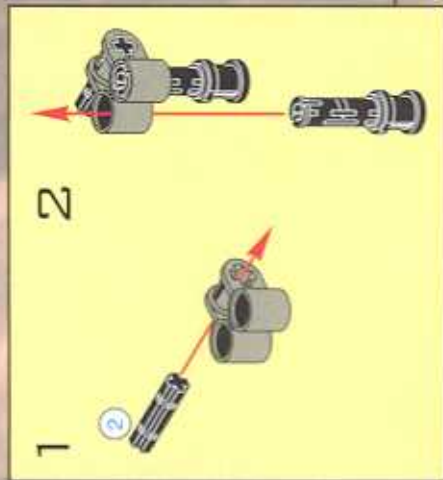



6
2x

6
2x

37

6
2x

6
1:1

2

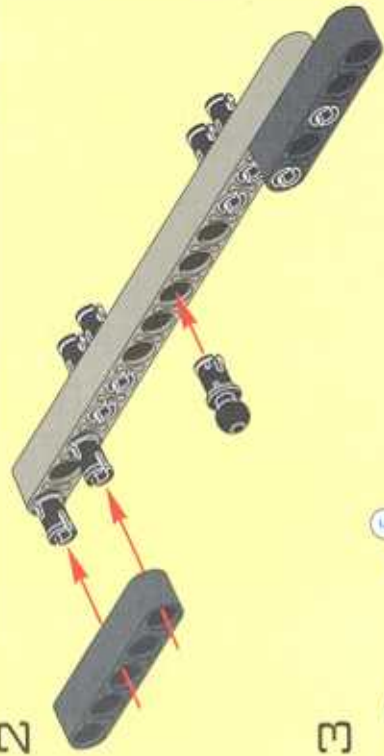

3

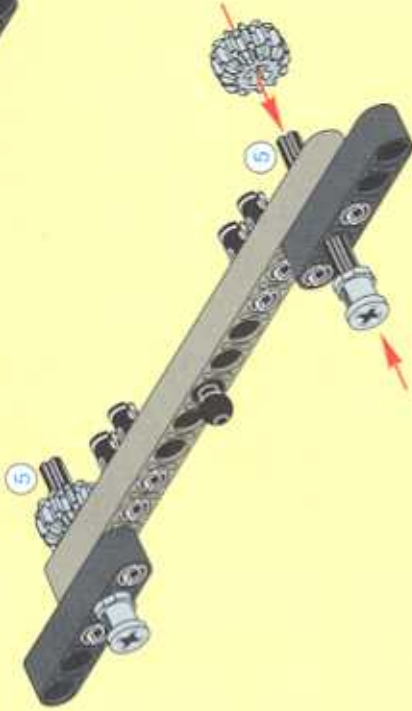

4

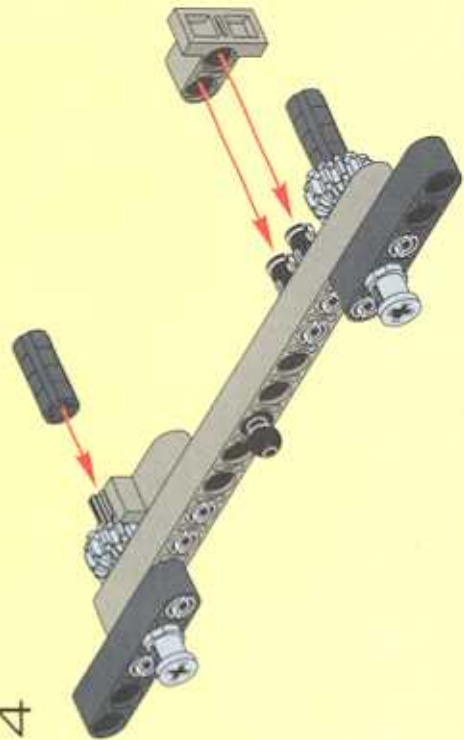

1

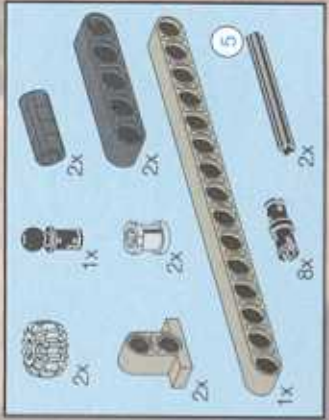
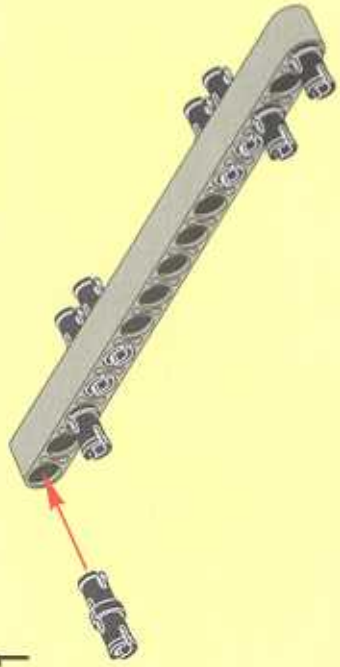

38

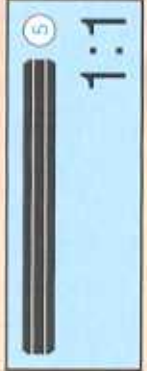
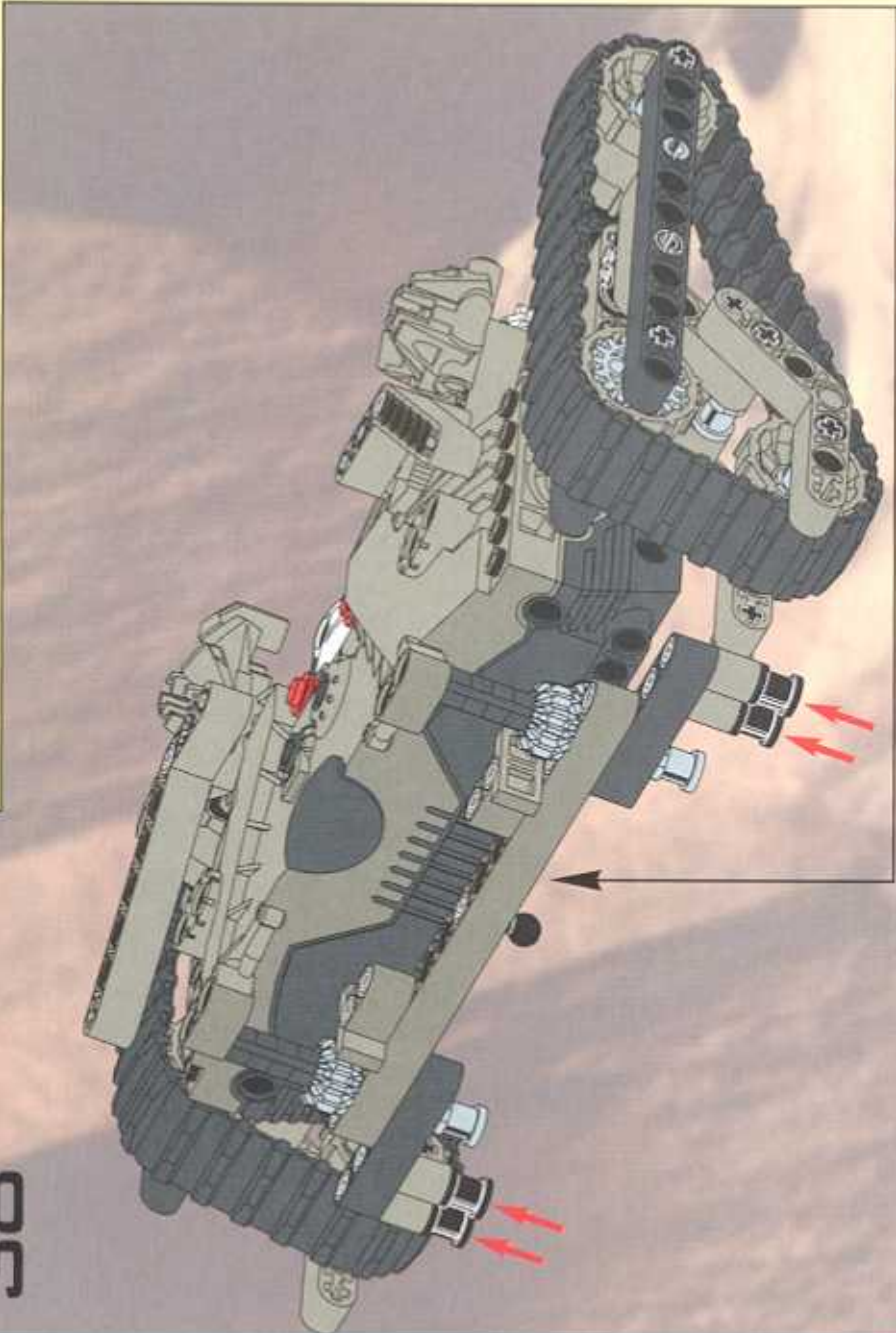

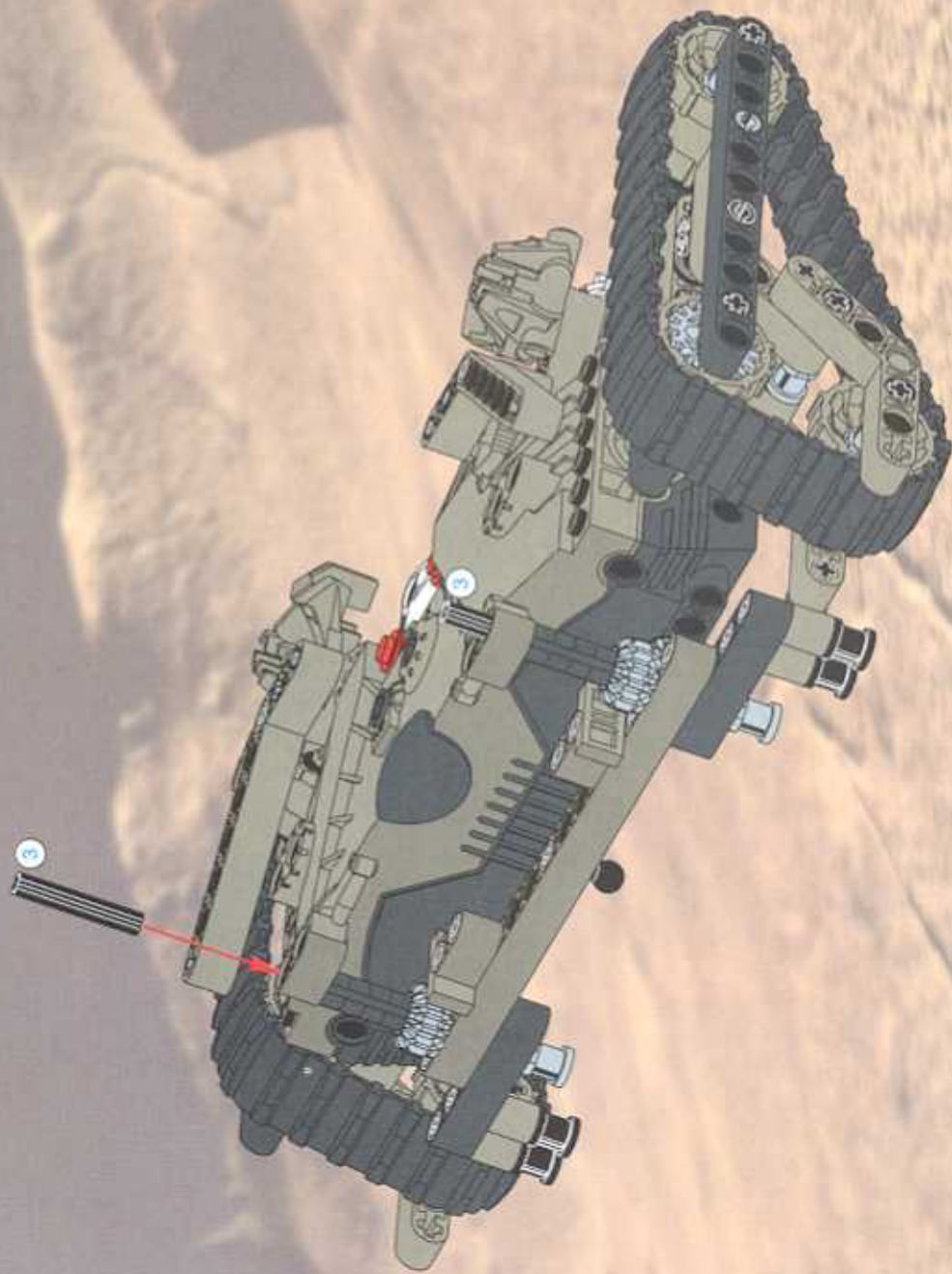

39



○ 2x

2x



40

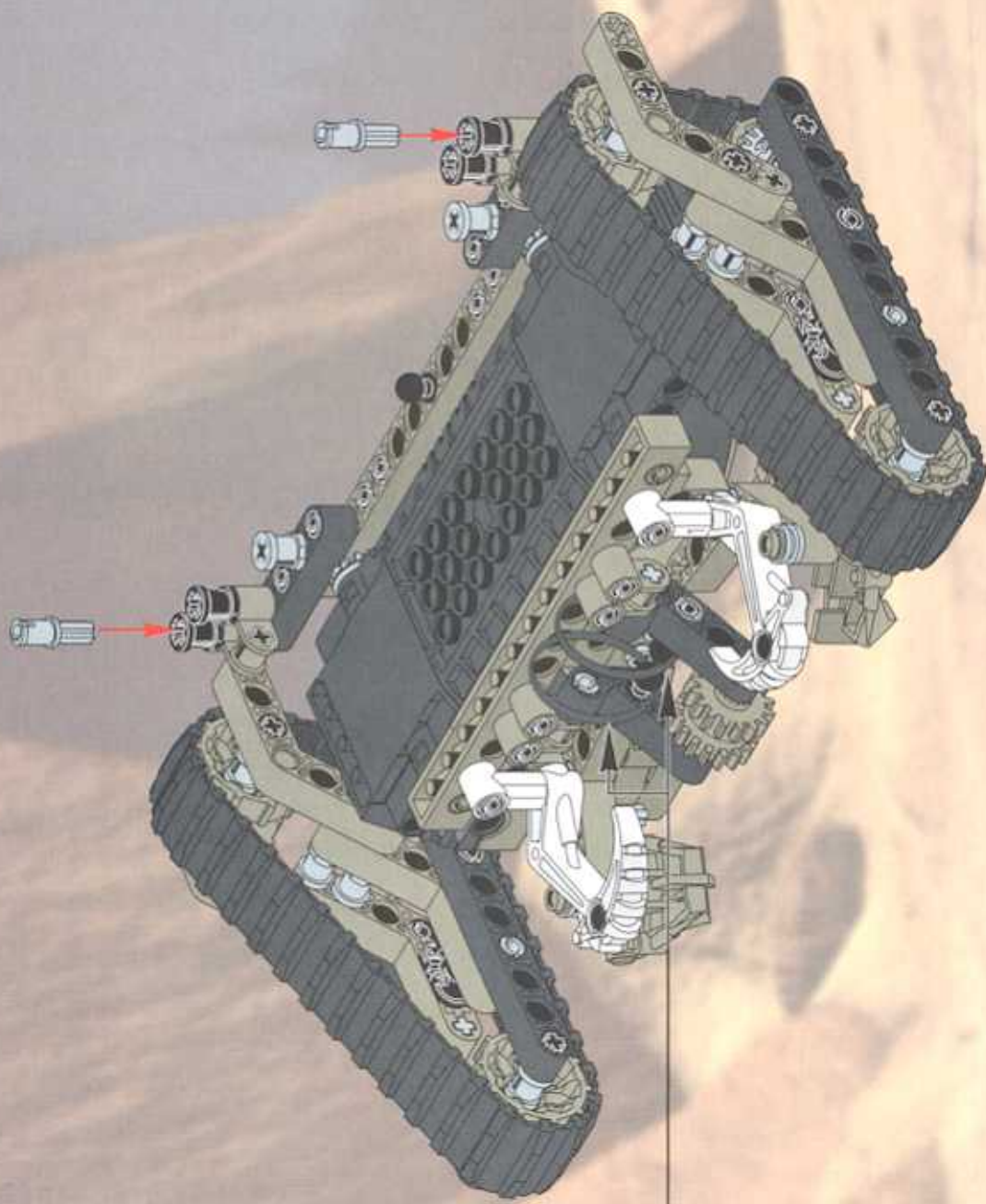

○ 2x

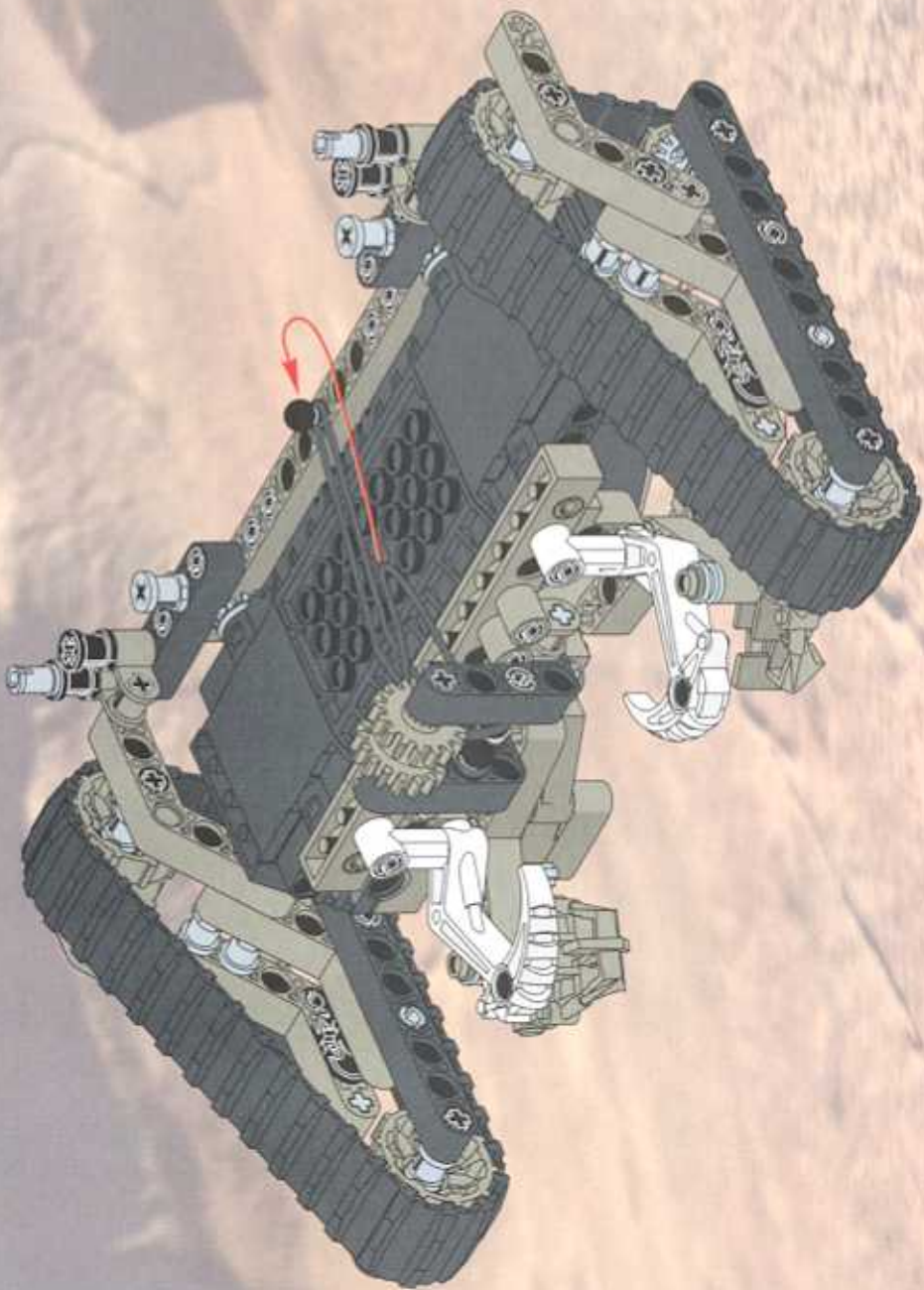

41



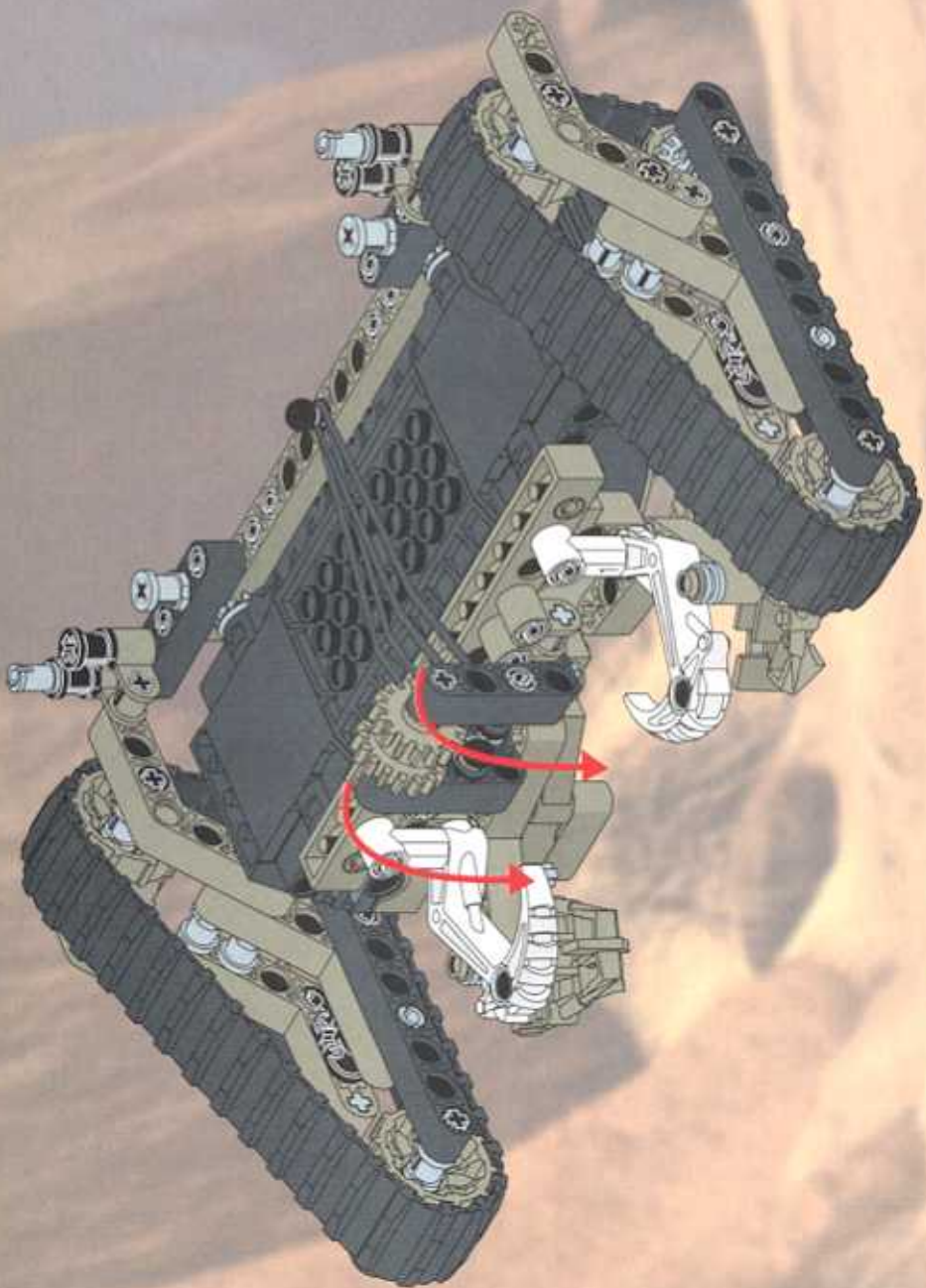

42

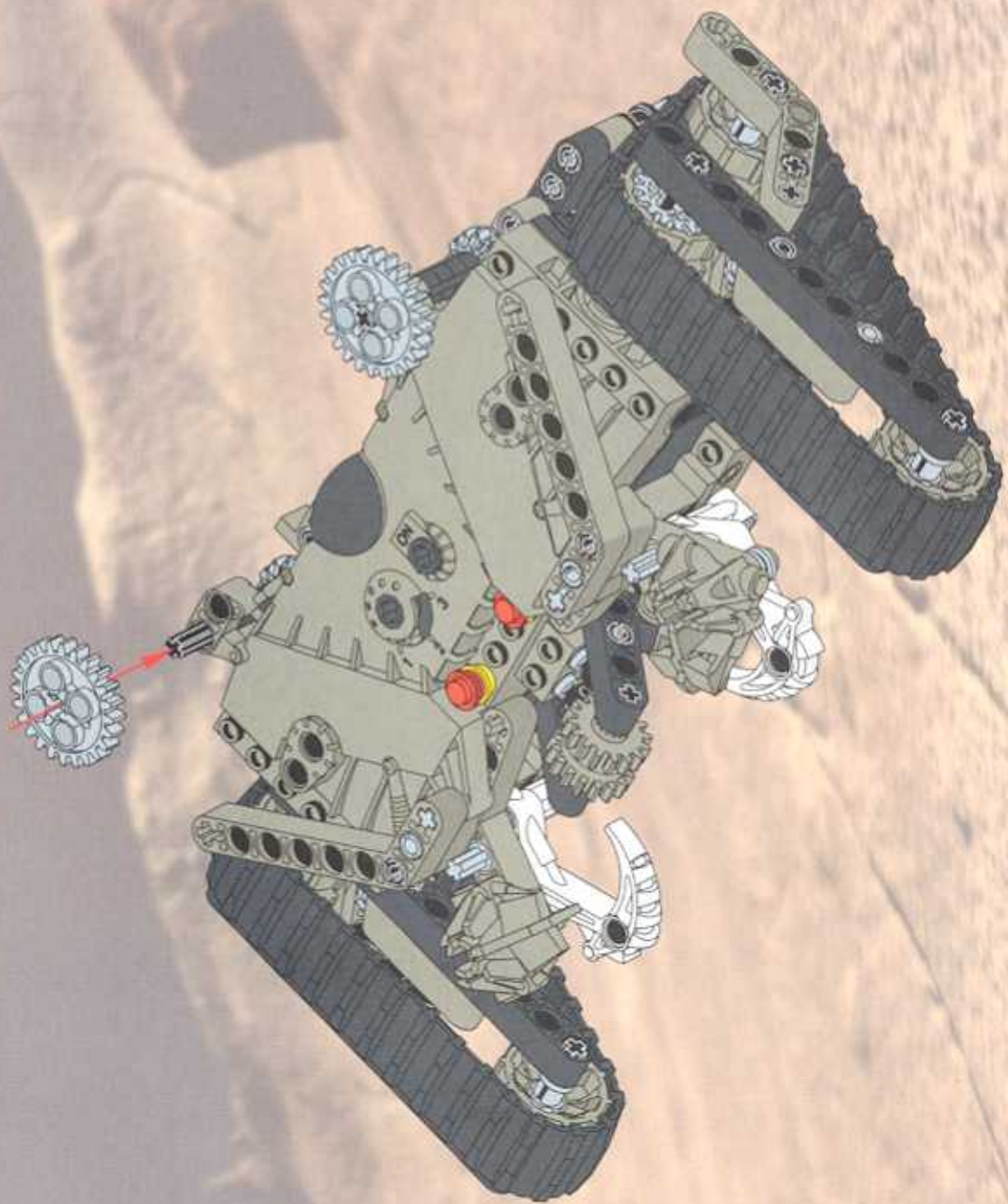

43

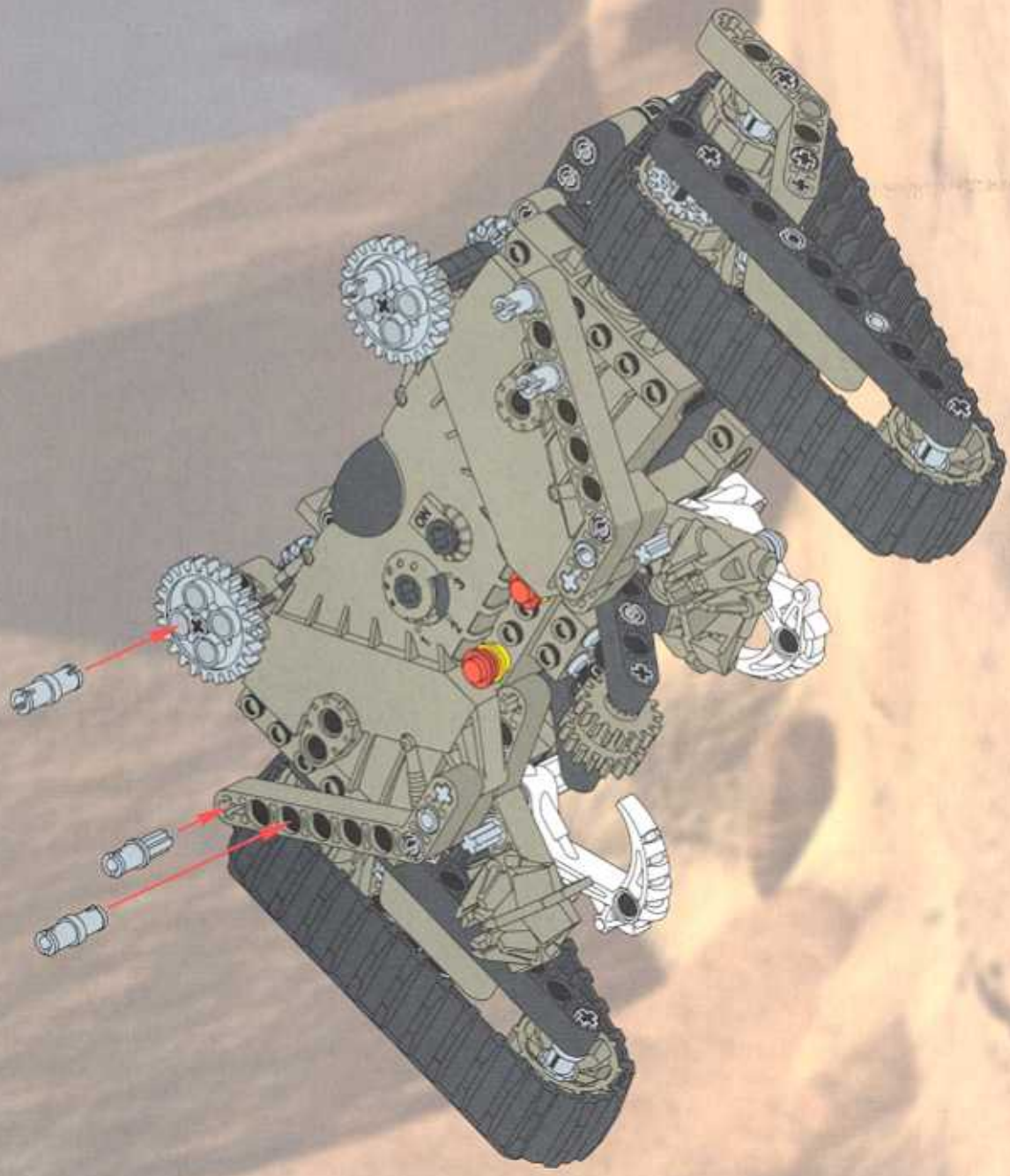

4x 

2x 

44

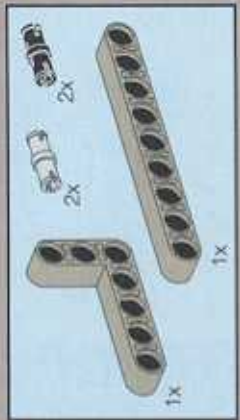
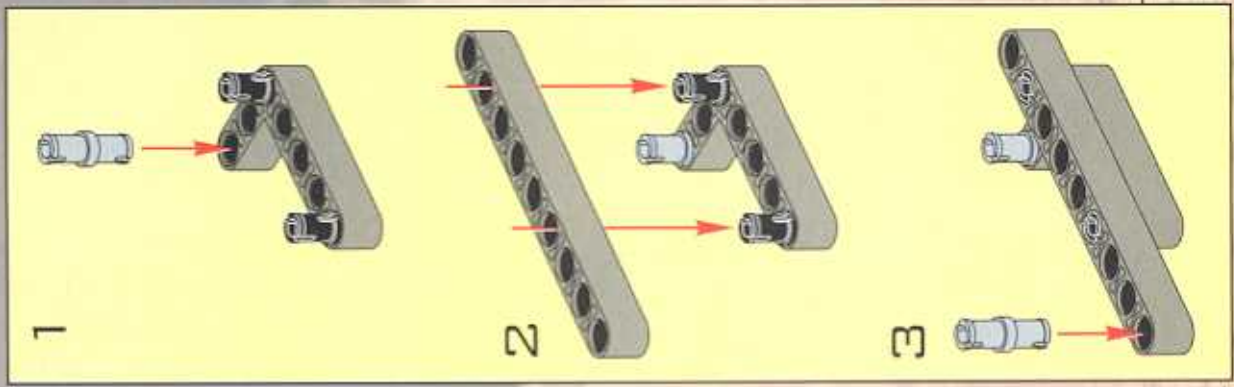
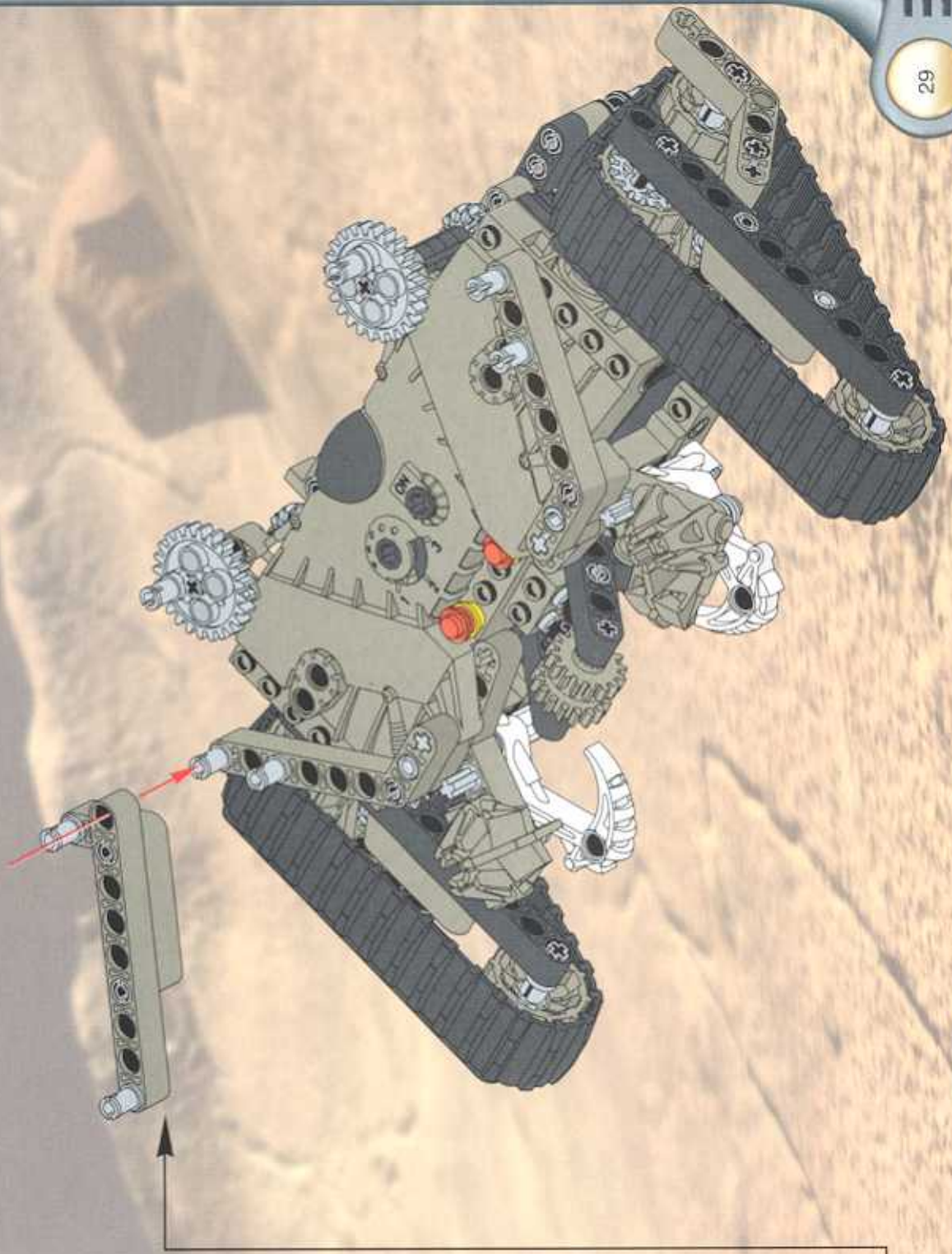

45

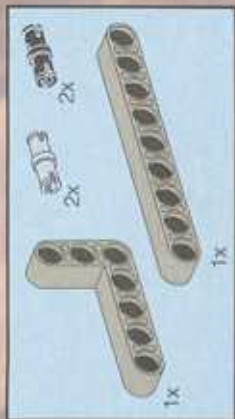
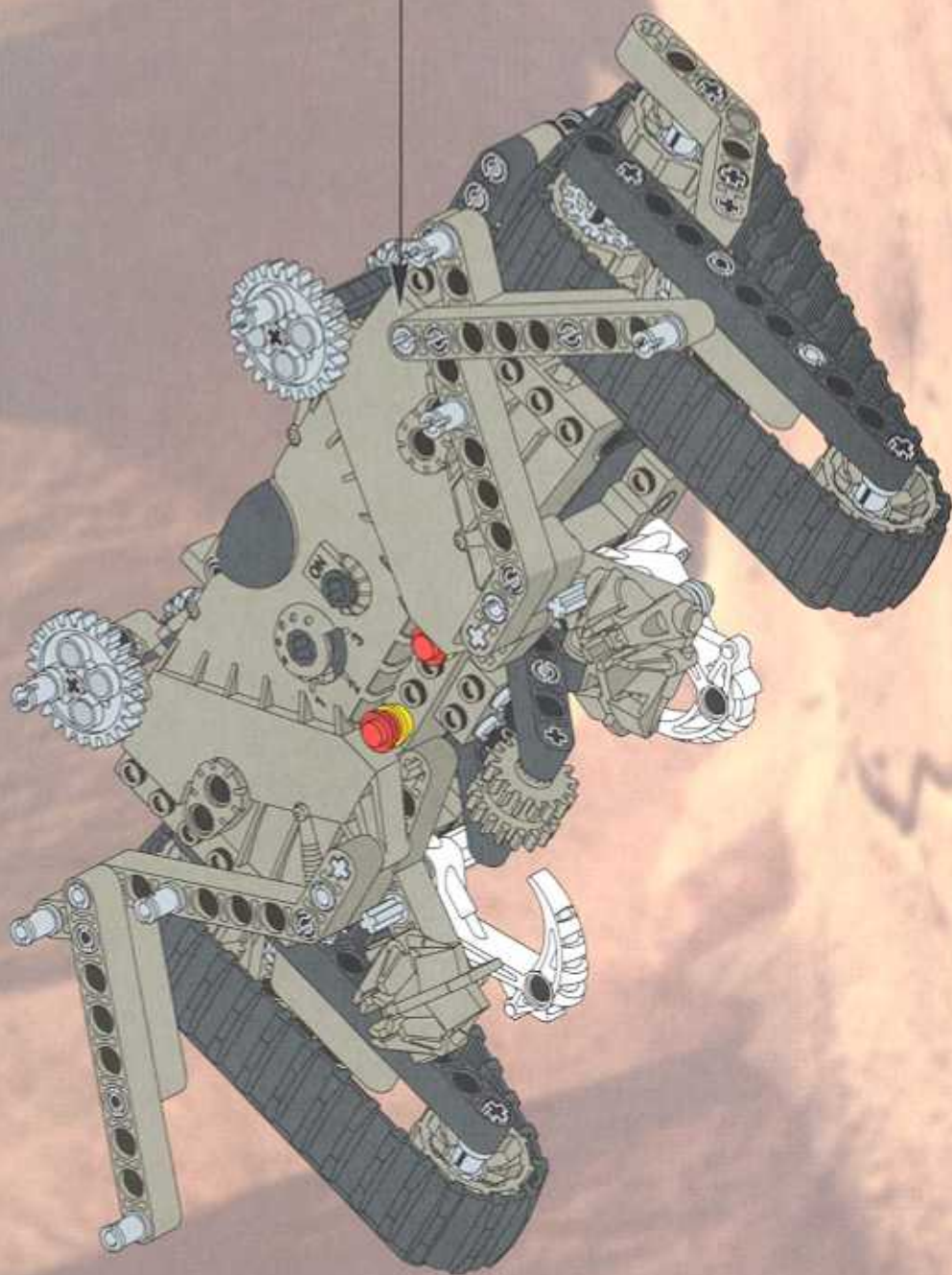
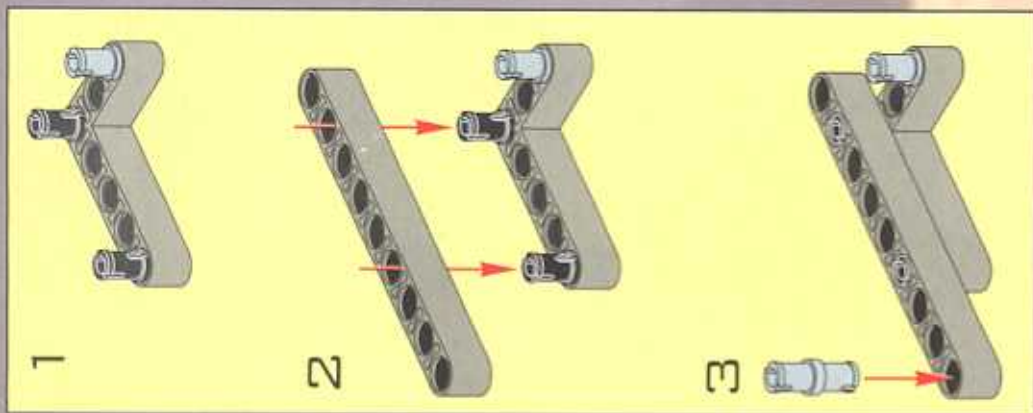

46

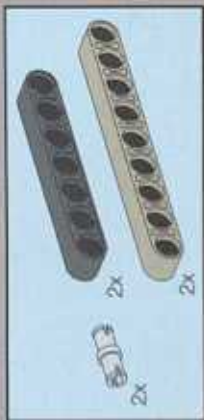
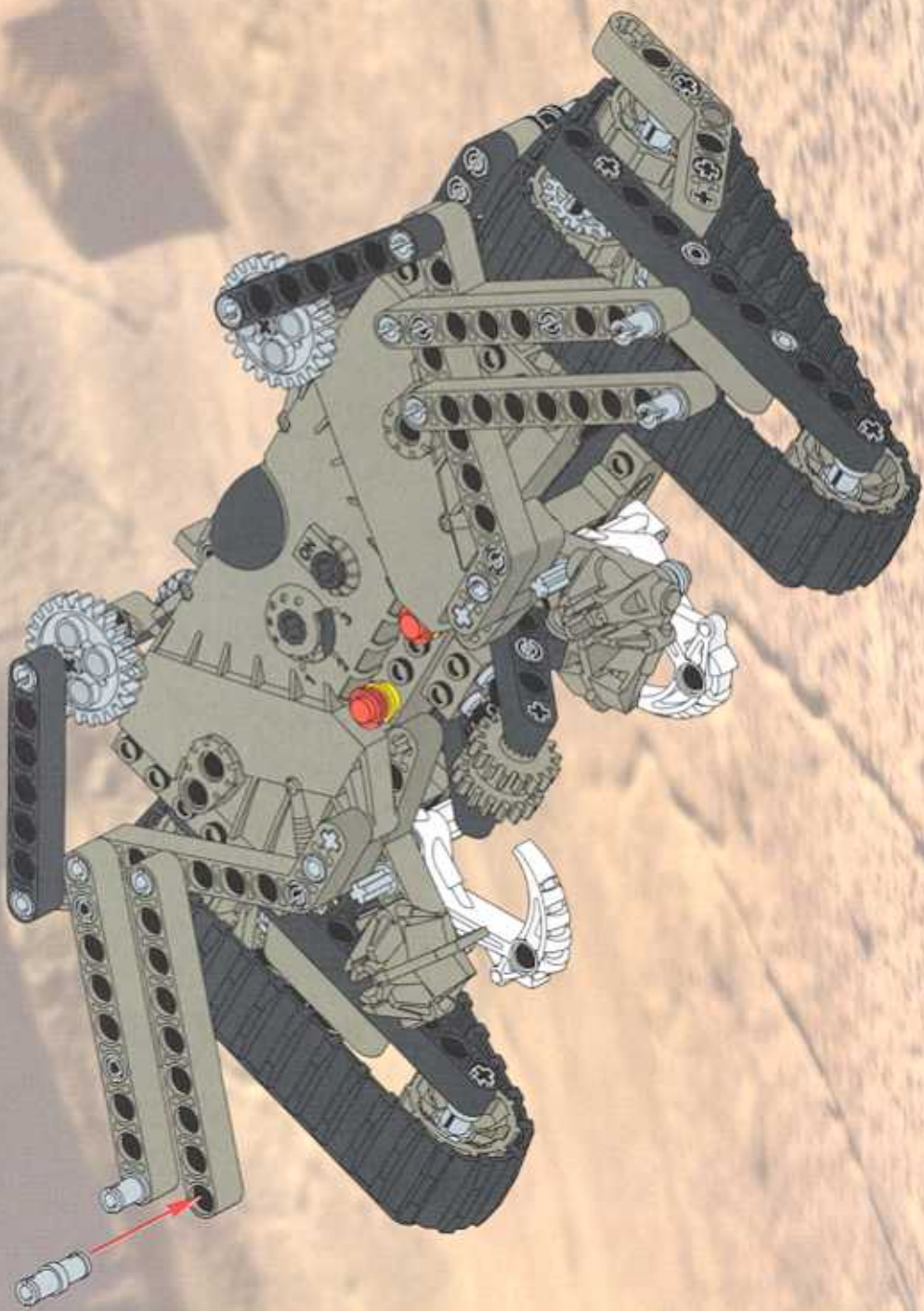

47

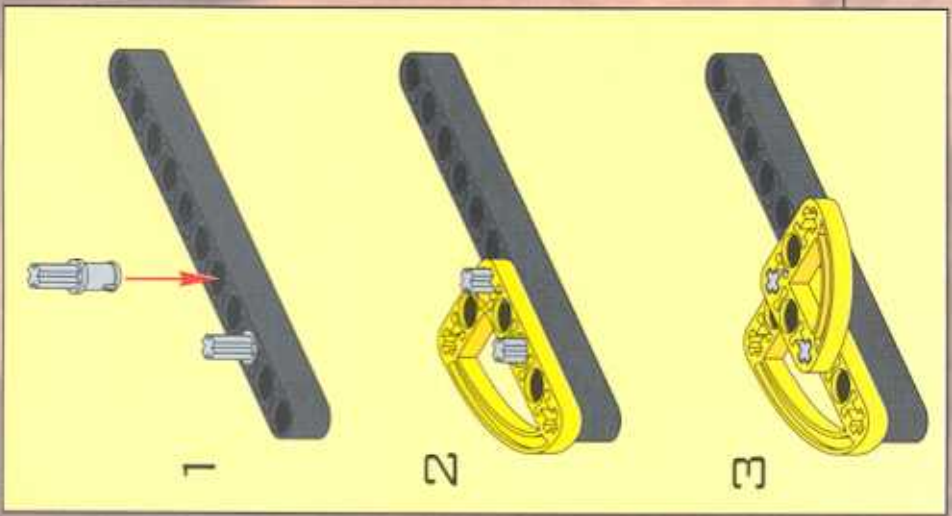
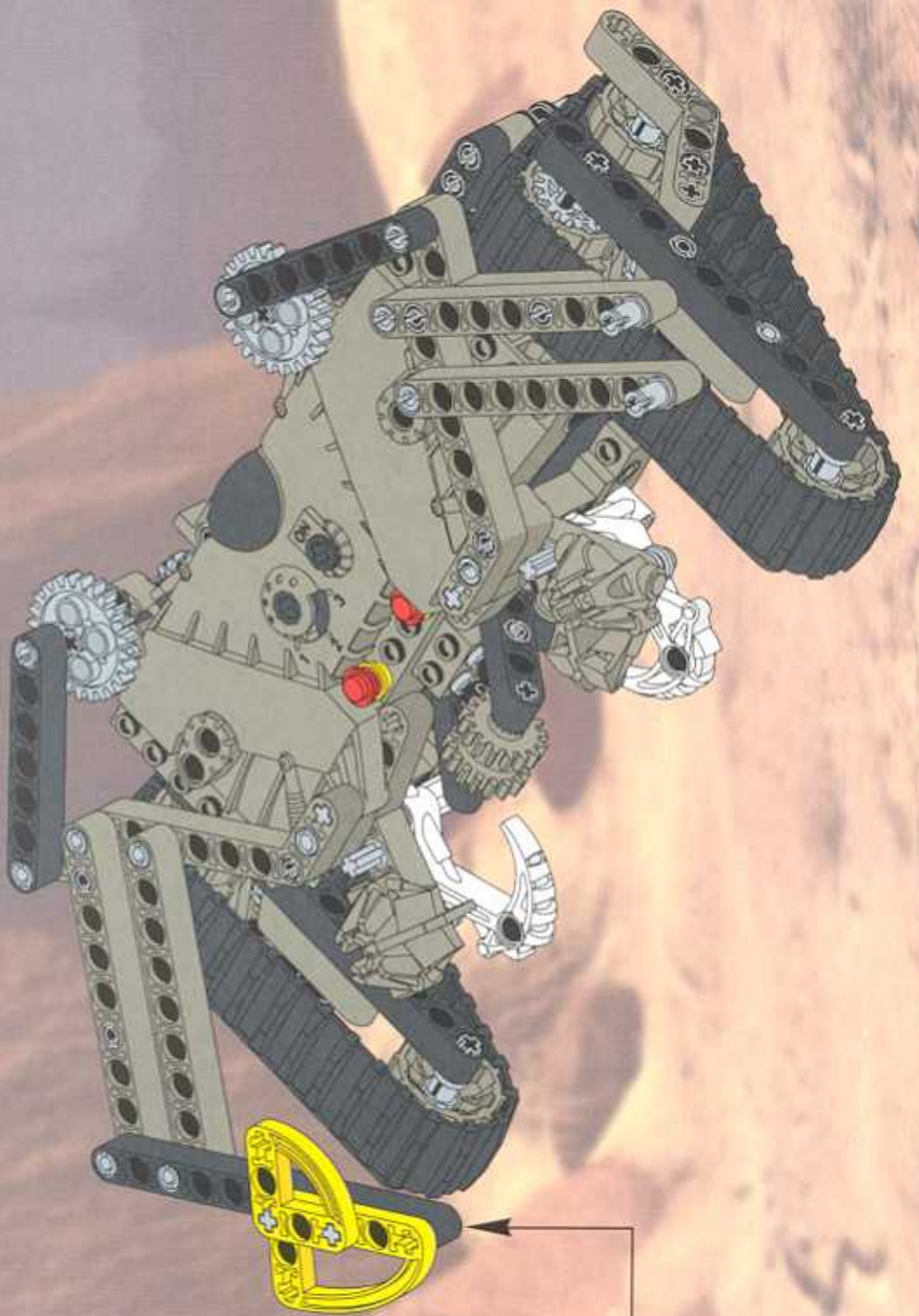

48

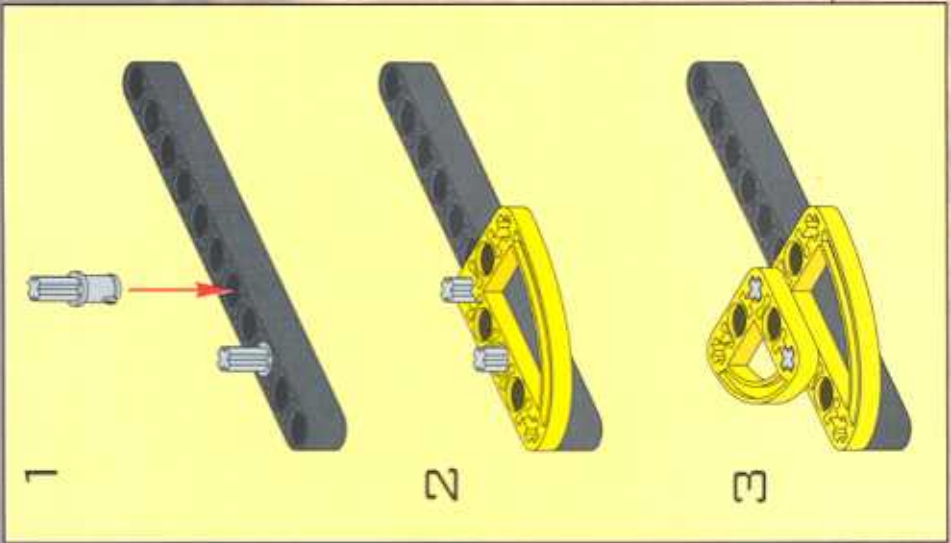
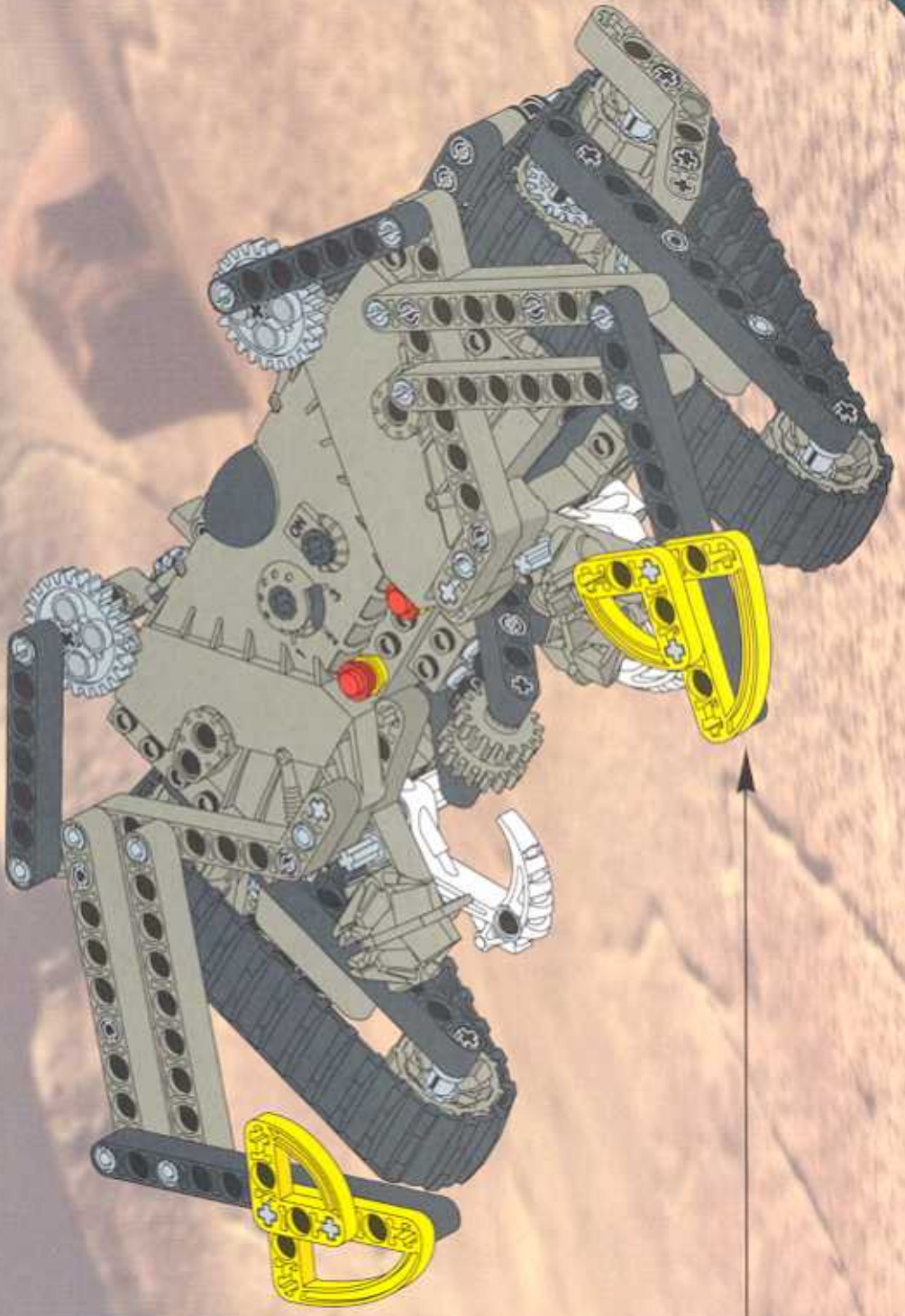

49



1



2



3



4



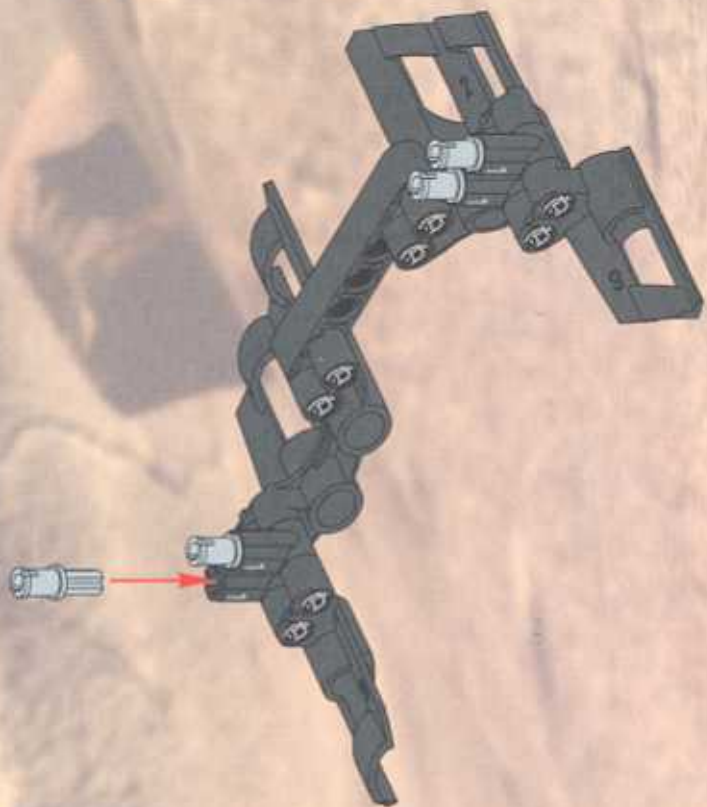

7

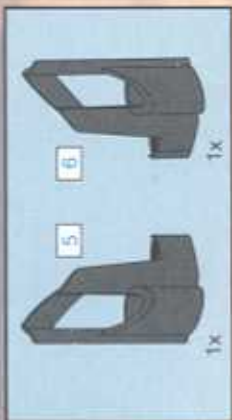

6



5

50

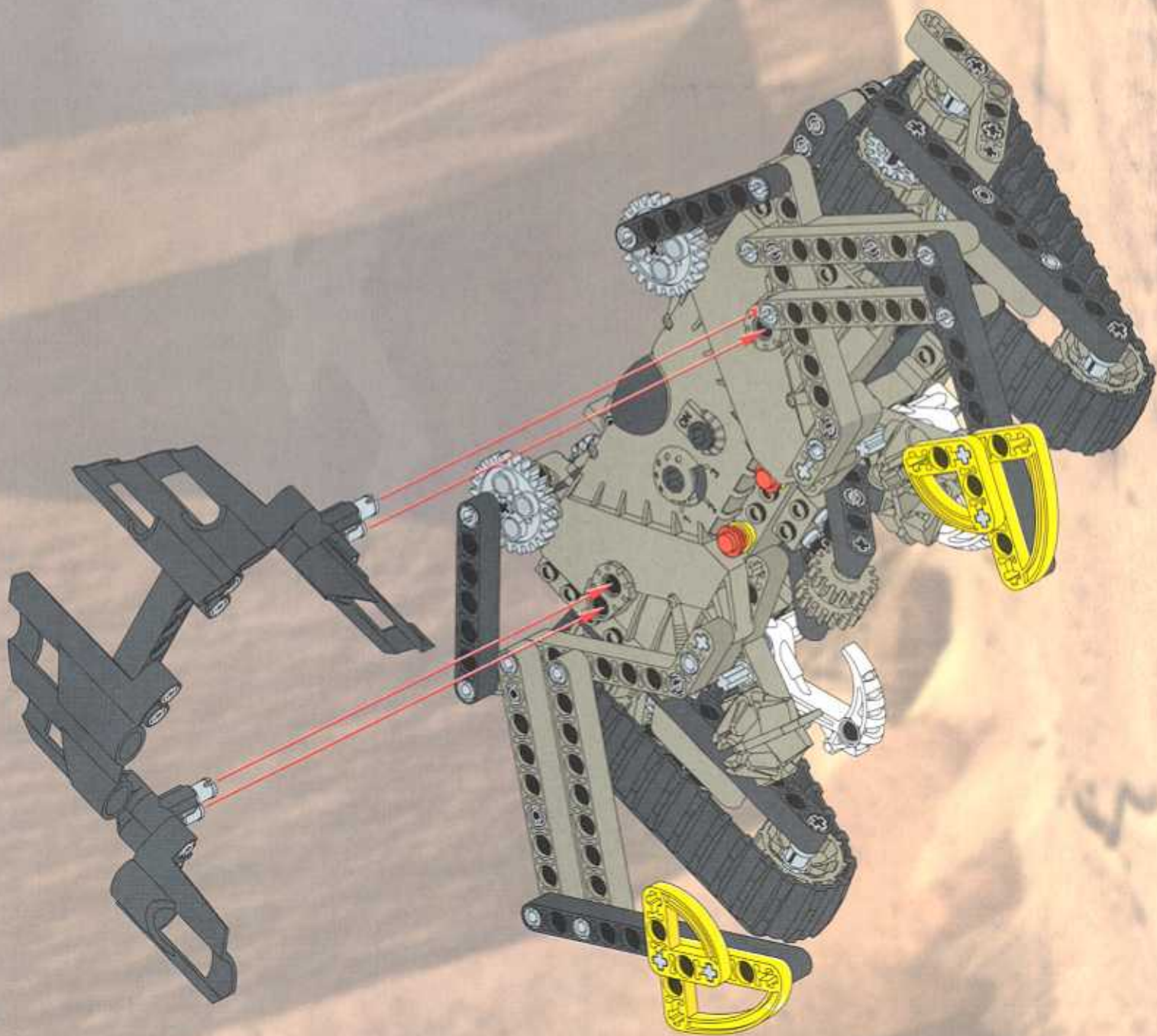



51

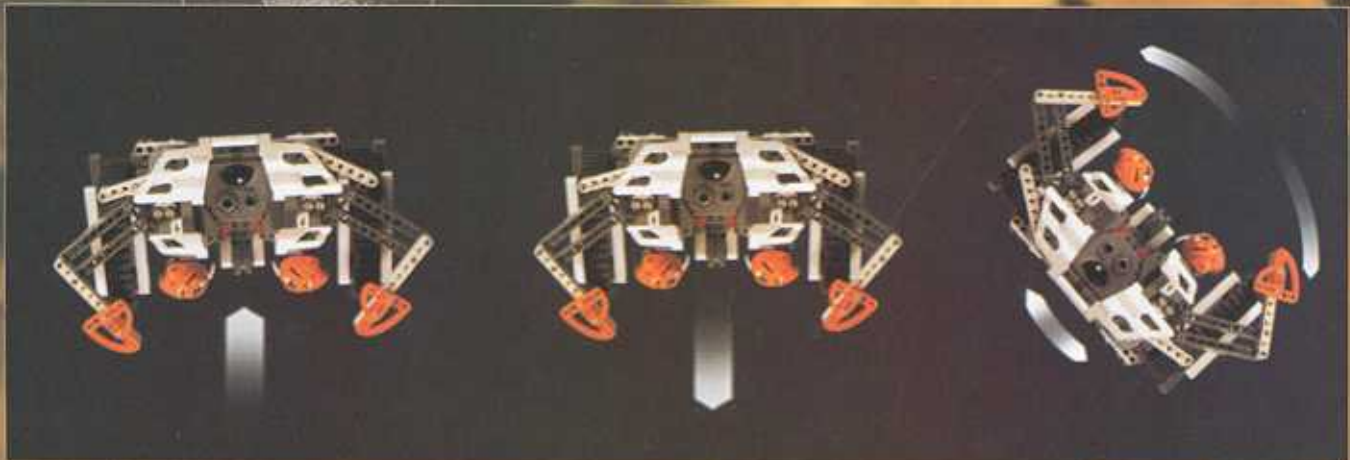

BIONICLE

www.bionicle.com

KANOHI

MIRU

AKAKU

KAUKAU

HAU

PAKARI

KAKAMA



TOA



TURAGA



MAHIKI

MATATU

RAU

HURA

RURU

KOMAU

72+



LEGO TECHNICAL

FIND THE POWER

ΜΥΑΚΑ & ΚΑΜΕ-ΡΑ
8538



ΠΥΙ-ΓΑΓΑ
8548



ΜΑΡΑΣ
8539



ΤΑΡΑΚΑΒΑ
8549



BIONICLE



ΟΝΕΒΑ
8542

ΝΟΚΑΜΑ
8543

ΜΑΤΑΥ
8541

ΝΥΨΥ
8544

ΒΑΚΑΜΑ
8540

ΧΗΝΕΥΙΑ
8545

ΛΕΒΑ 8535

ΟΝΥΙΑ 8532

ΠΟΧΑΤΥ 8531

ΤΑΧΥ 8534

ΓΑΛΙ 8533

ΚΟΡΑΚΑ 8536



ΧΑΥ

ΠΑΚΑΡΙ

ΜΙΡΥ

LEGO TIME
AN ADVENTURE OF YOUR AGE



LEGO SOFTWARE



PC CD-ROM



GAME BOY™ ADVANCE



UNIVERSAL

LEGO, the LEGO logo and BIONICLE are trademarks of the LEGO Group. ©2001 The LEGO Group.



8242

8+

8240

7+



8241

7+

www.LEGO.com
JOIN THE FUN!
www.LEGO.com/createnrace

LEGO TECHNIC



BIONICLE

MANAS

9+

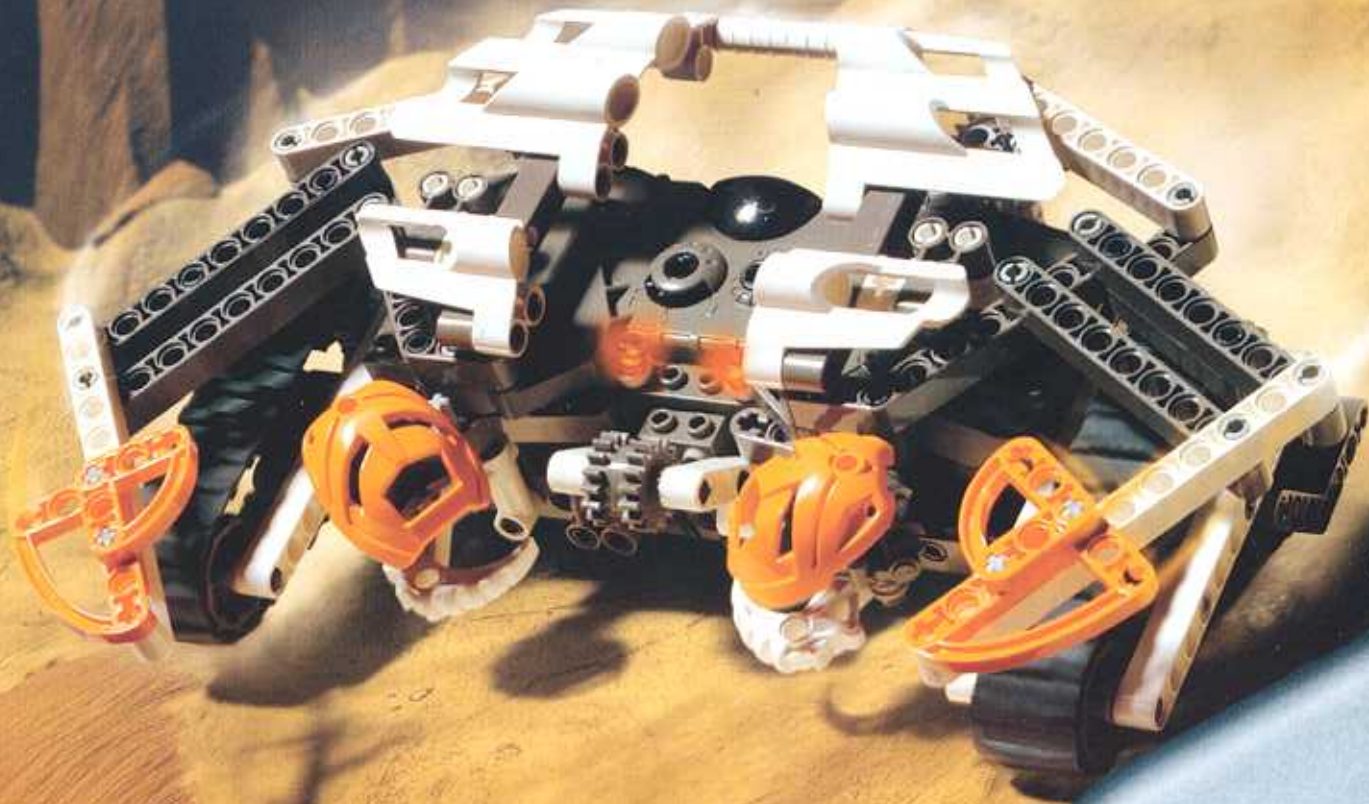

8539

LEGO TECHNIC

3

4

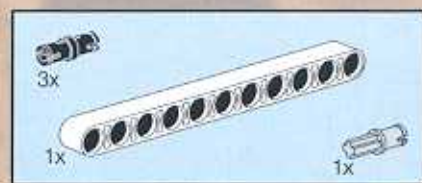
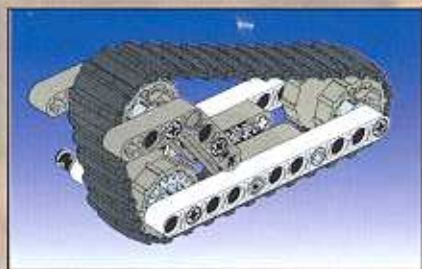
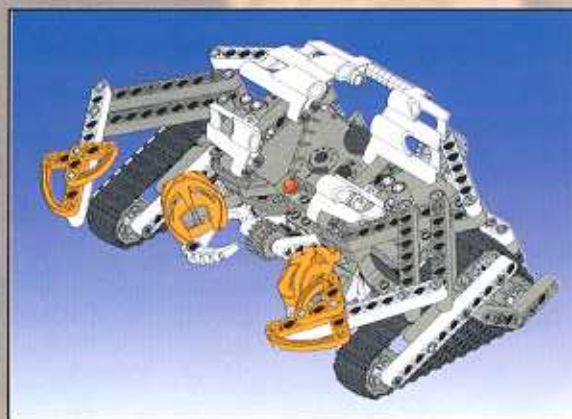

1

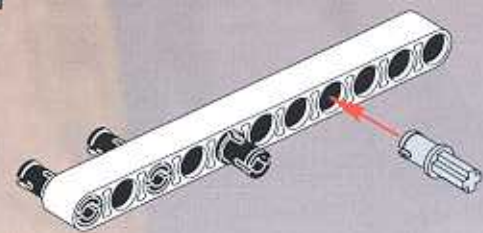

2

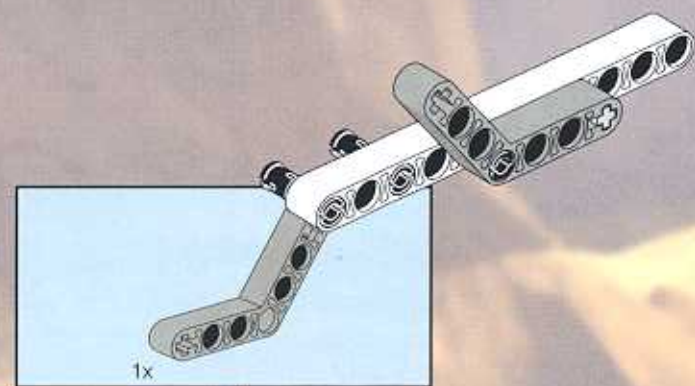

3

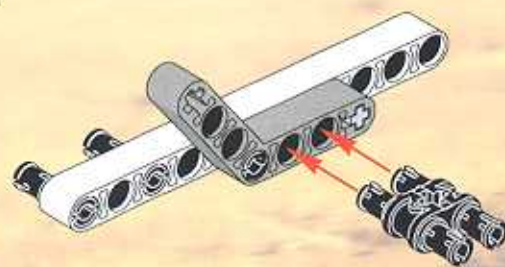

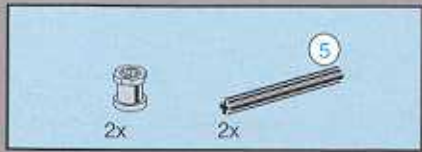

4

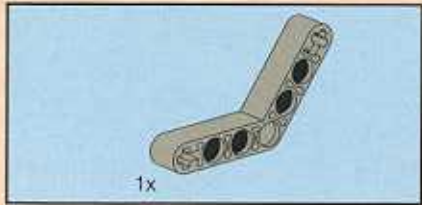
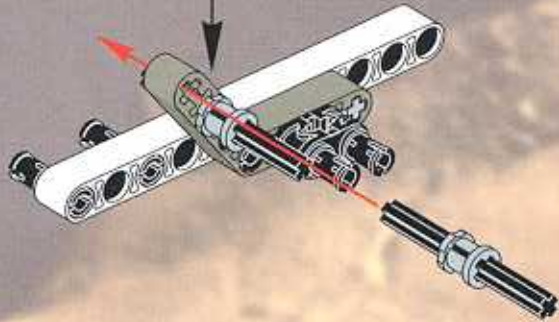
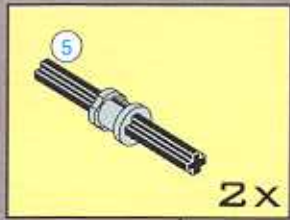

5

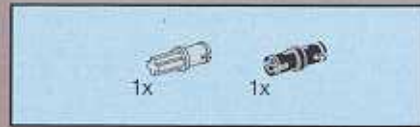
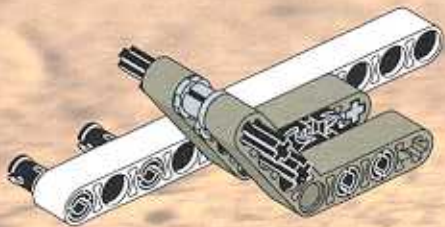

6

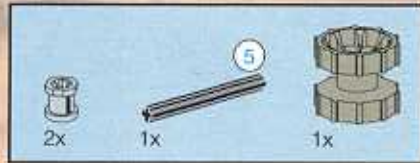
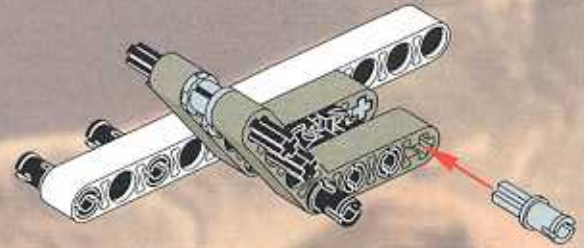

7

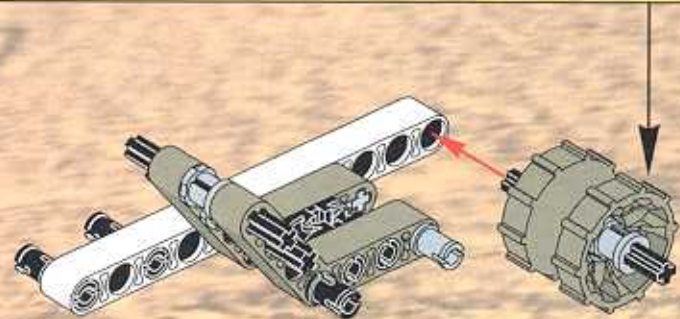
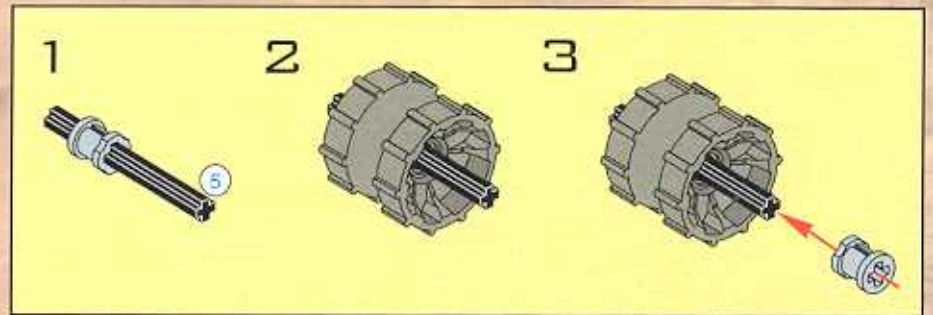

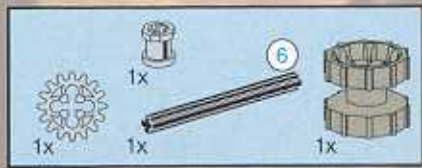

8

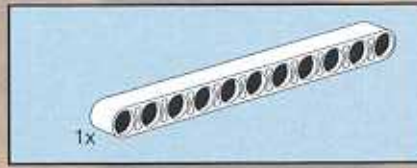
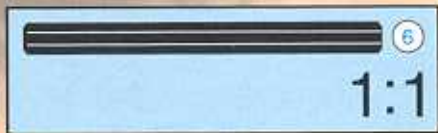
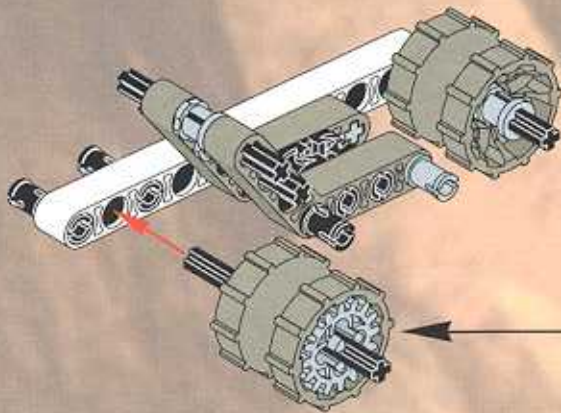
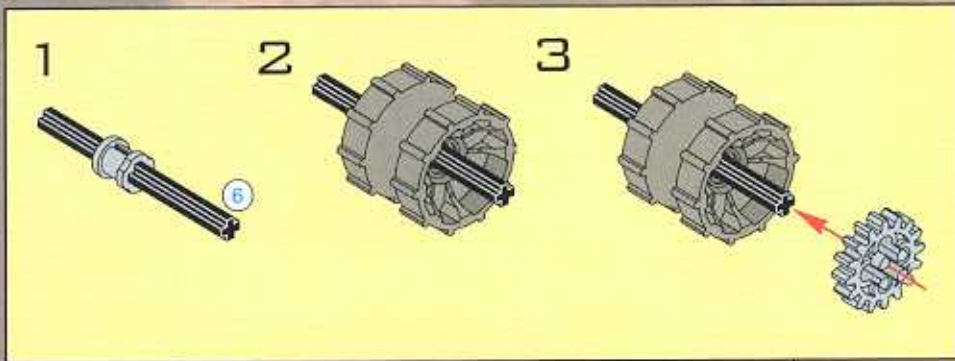

9

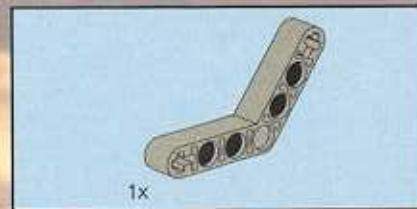
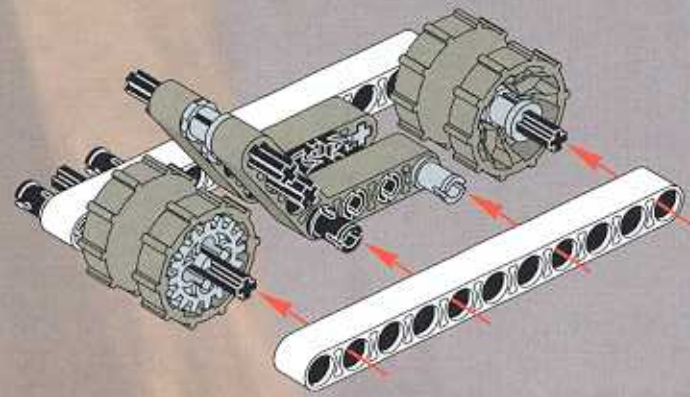

10

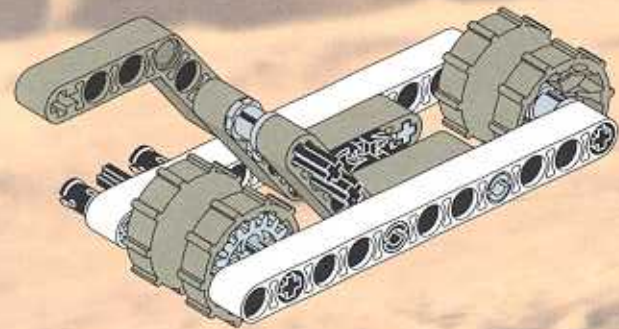

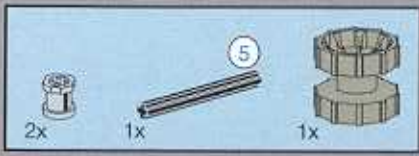

11

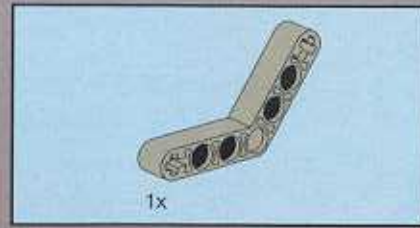
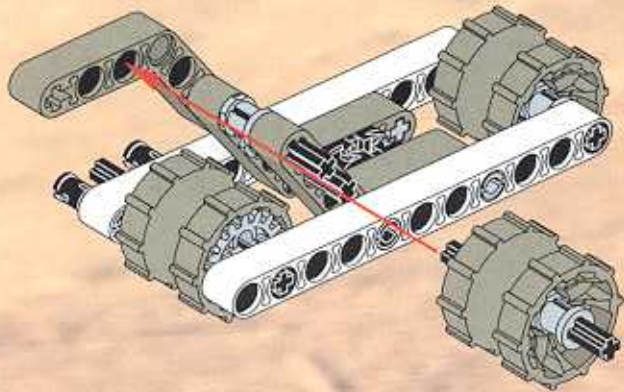
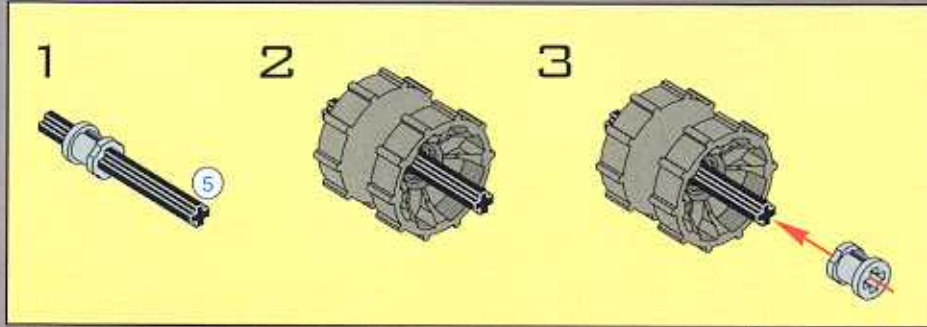

12

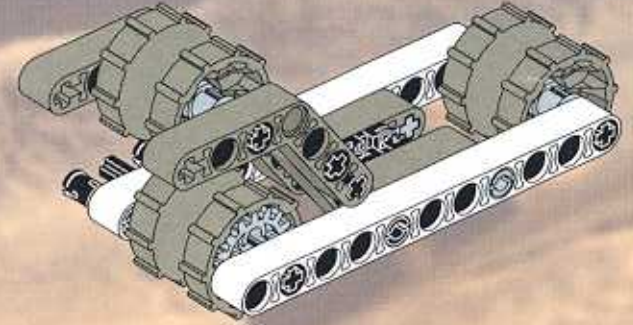

13

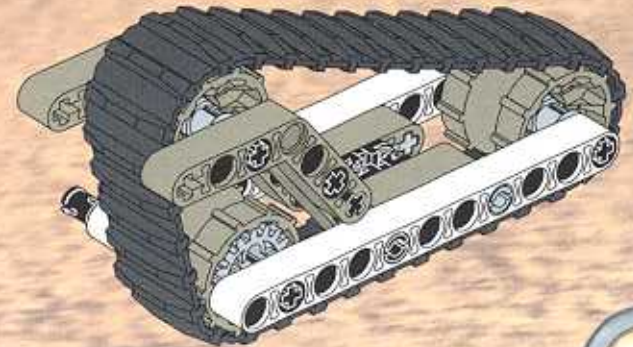

1



2

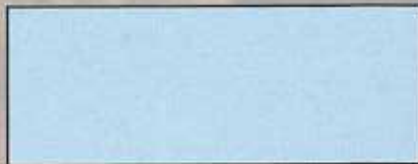

14

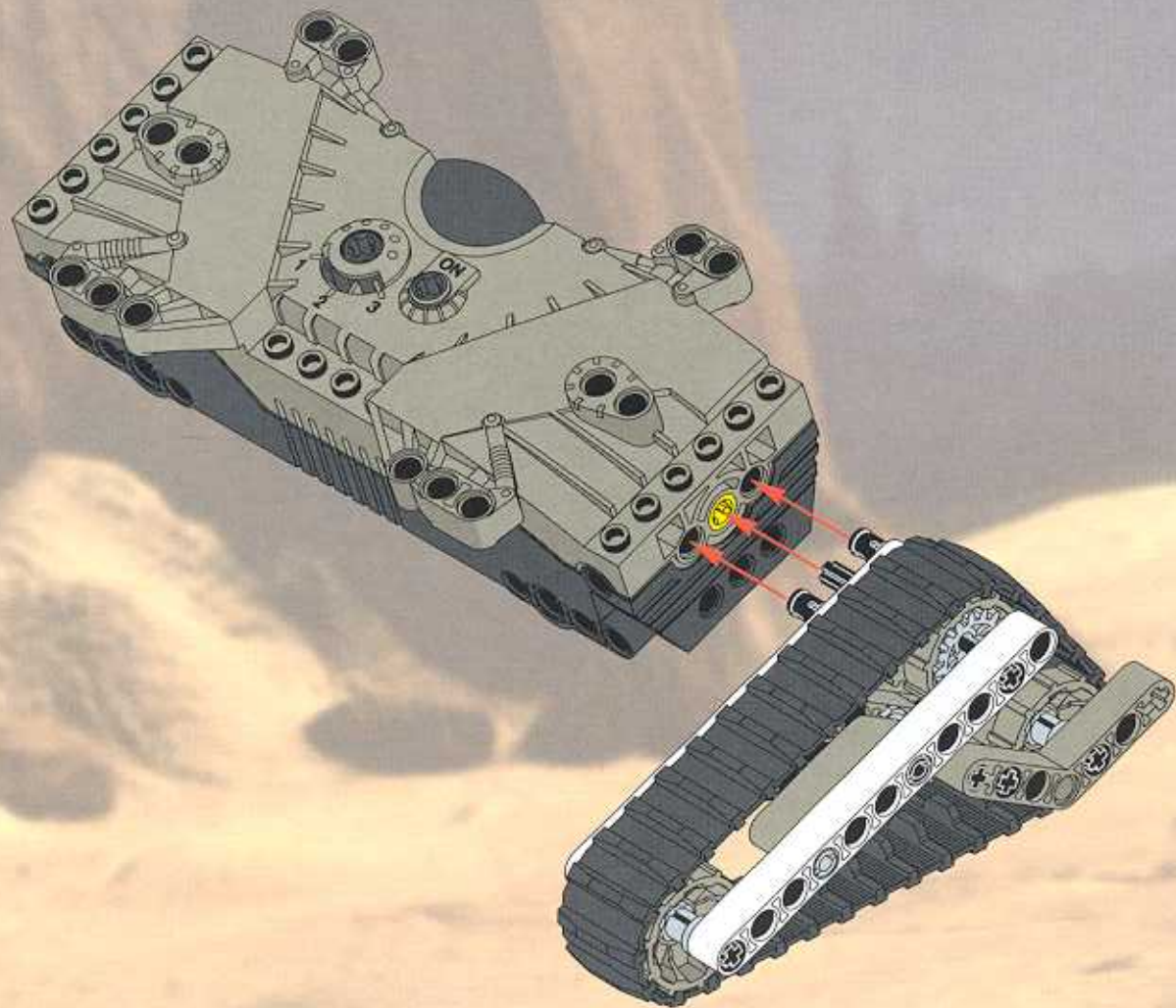

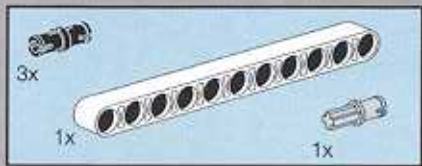
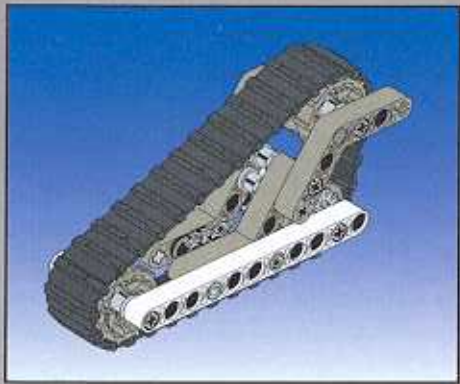

15

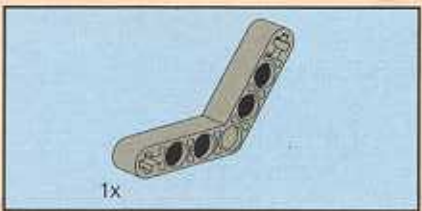
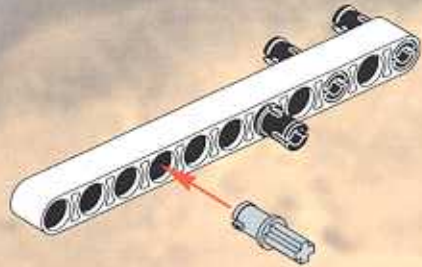

16

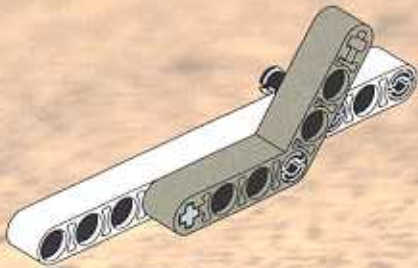

17

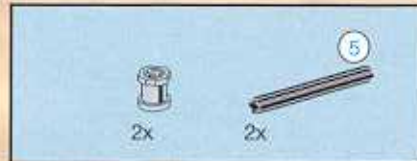
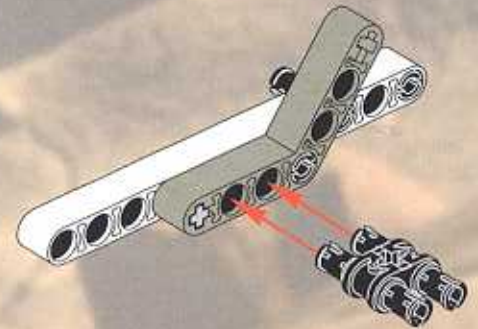

18

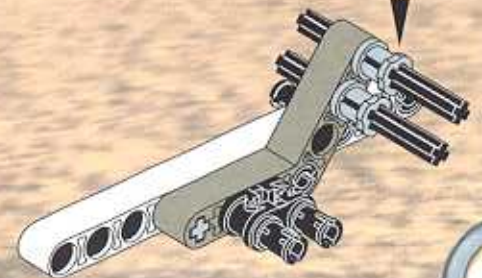
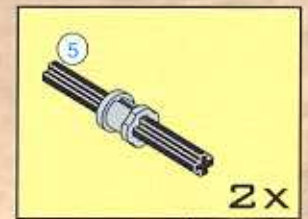

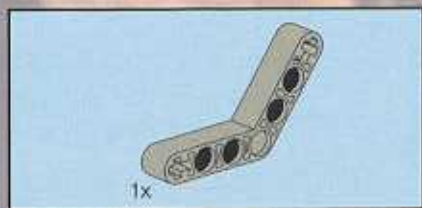

19

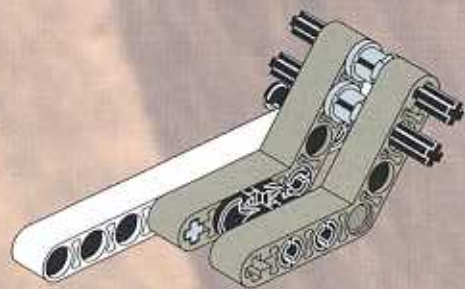

20

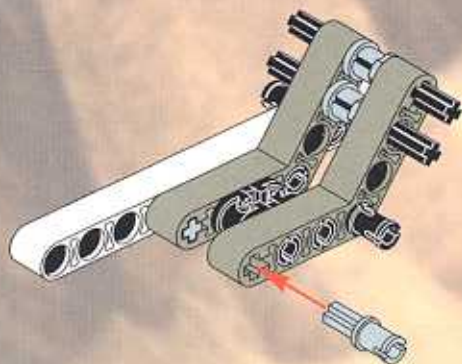

21

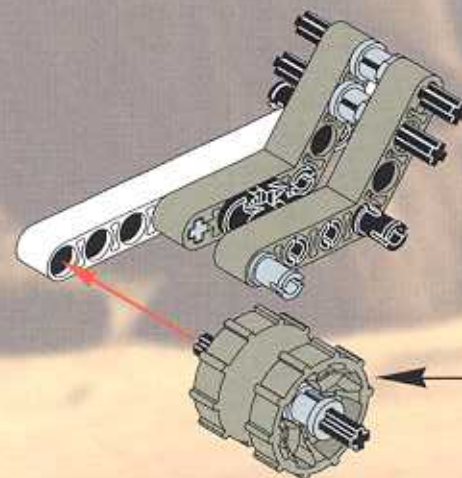
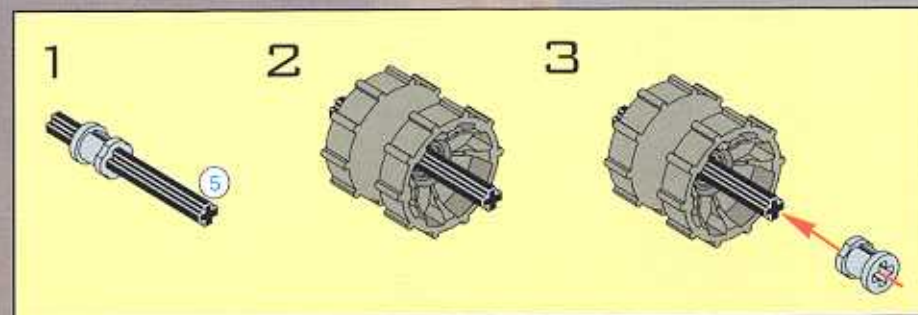

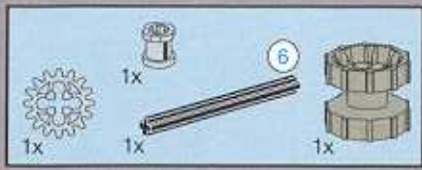

22

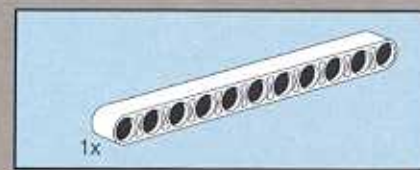
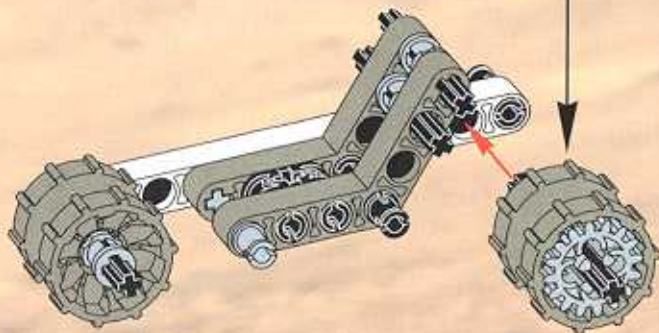
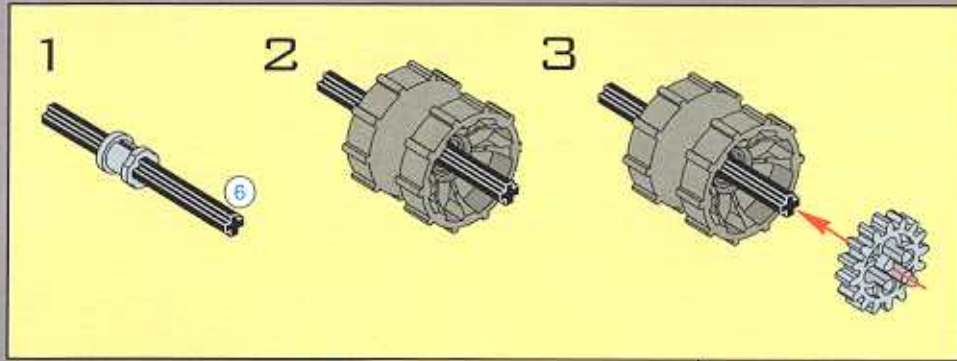

23

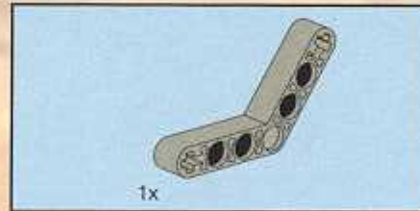
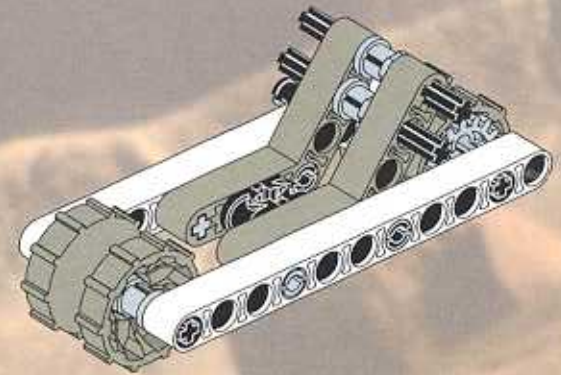

24

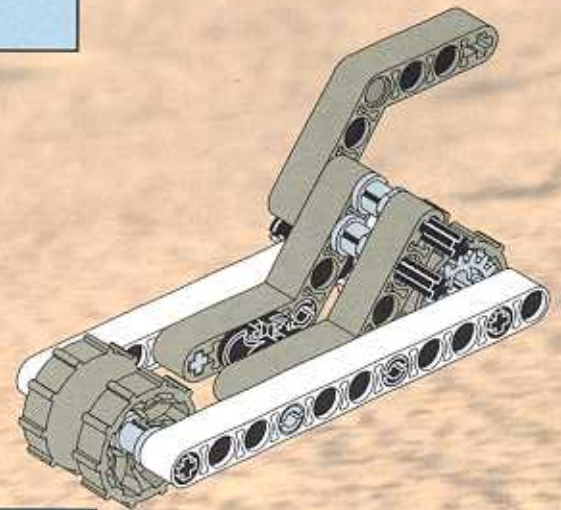



25

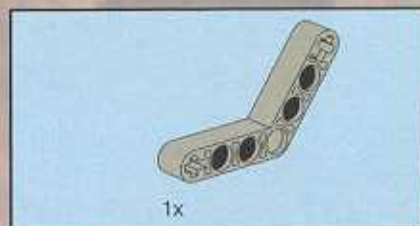
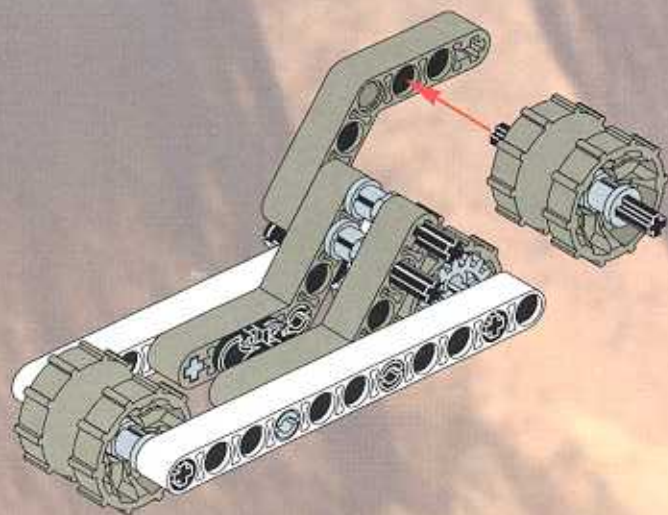
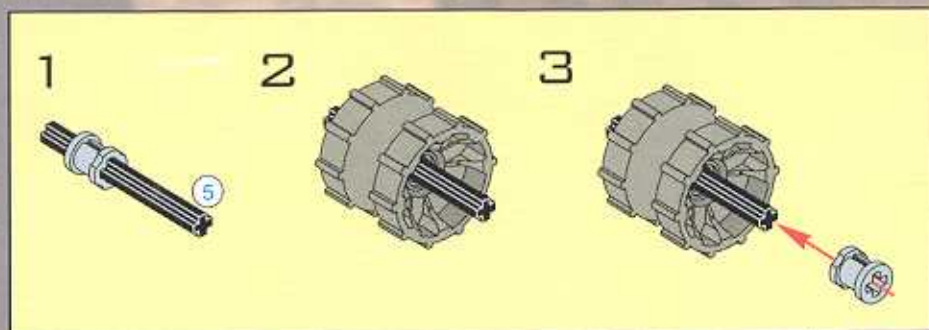

26

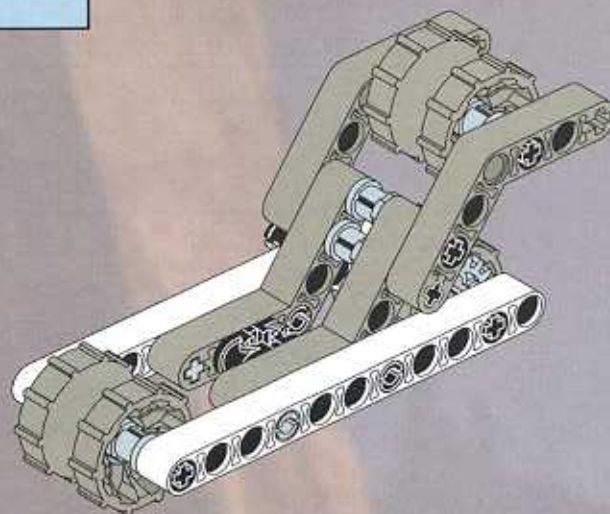

27

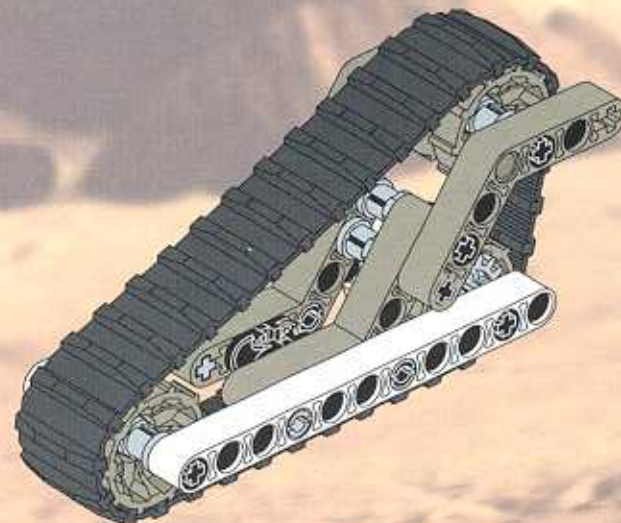

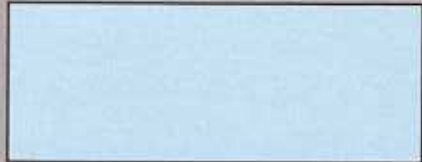

28

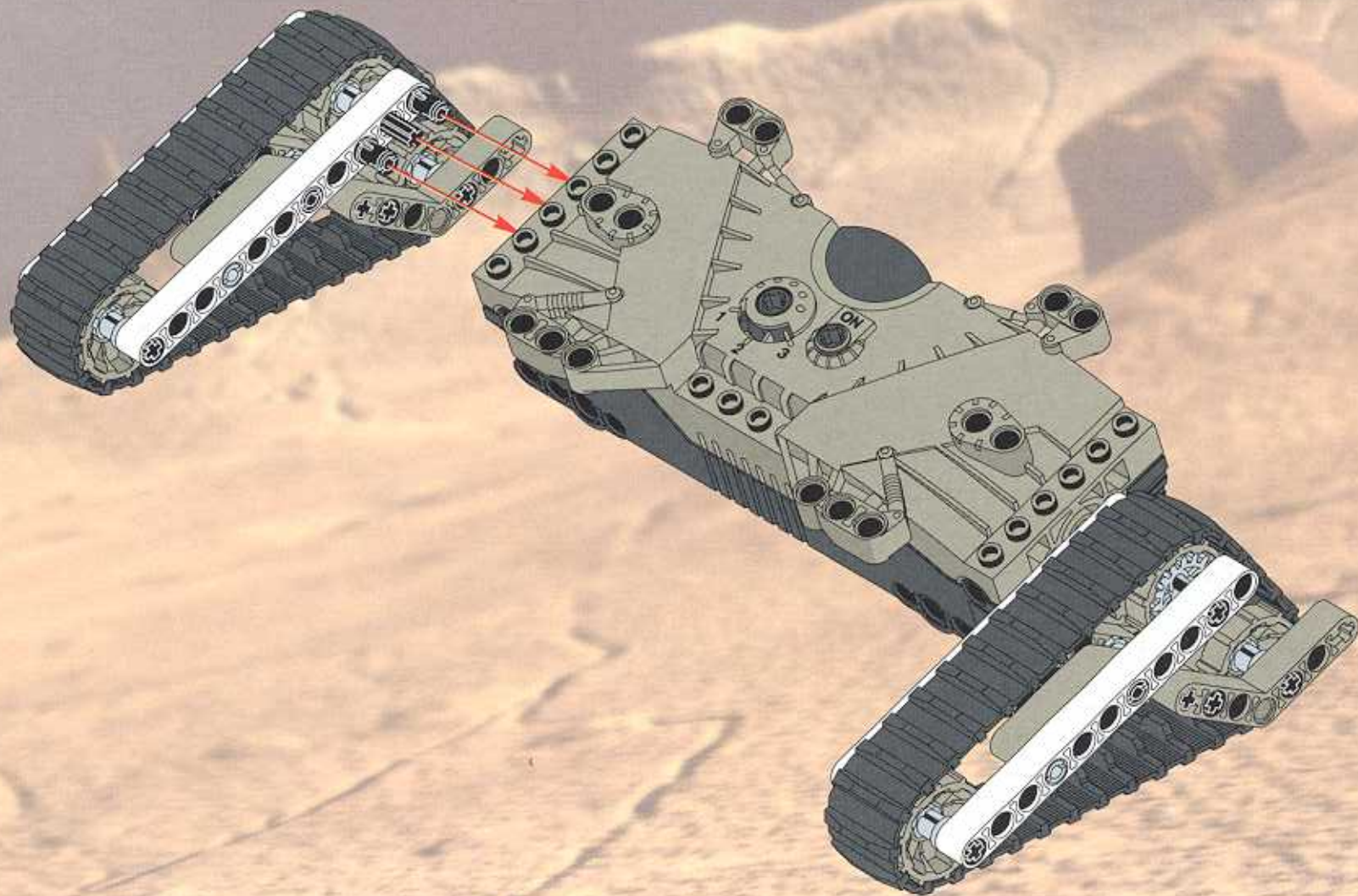

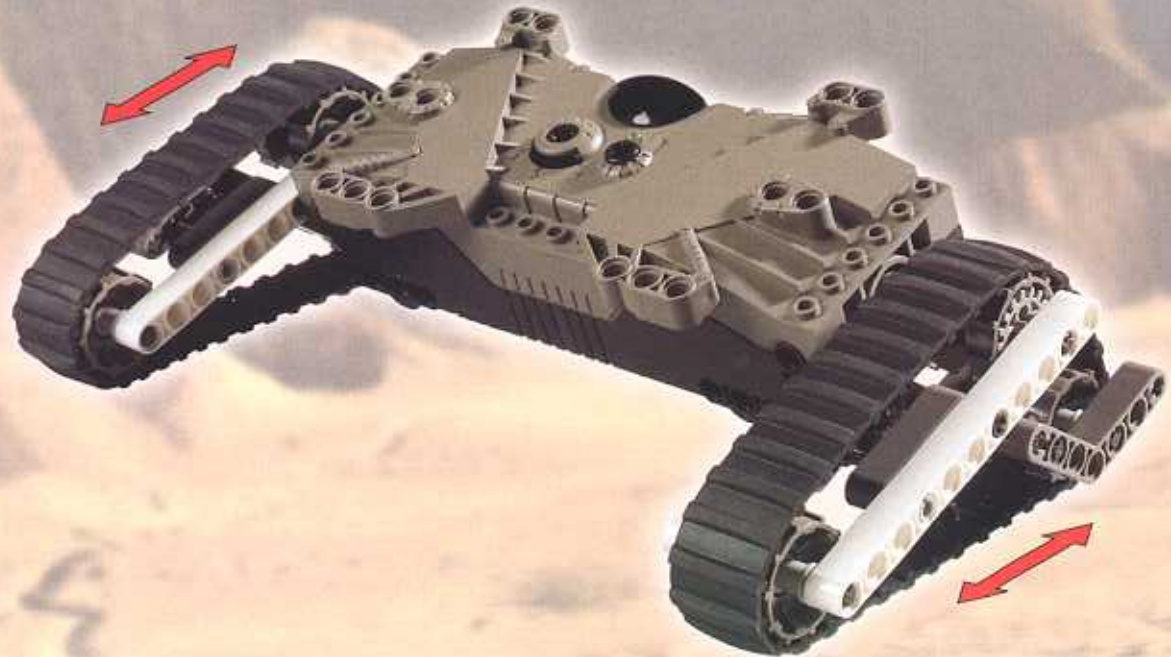
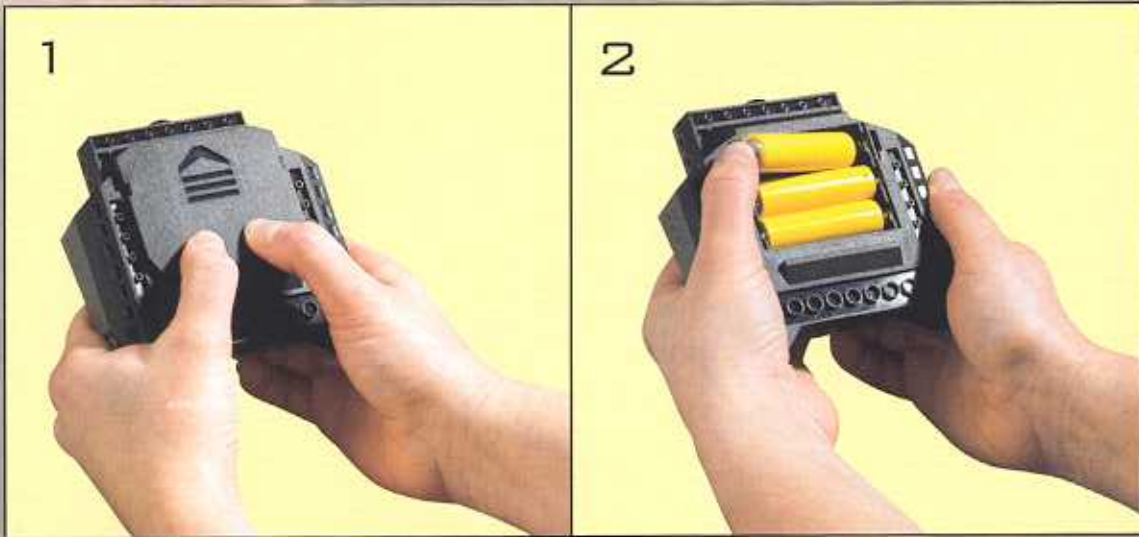

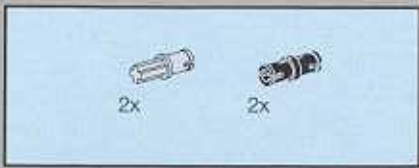

29



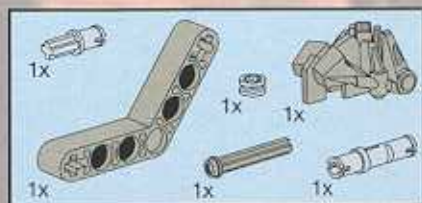

30

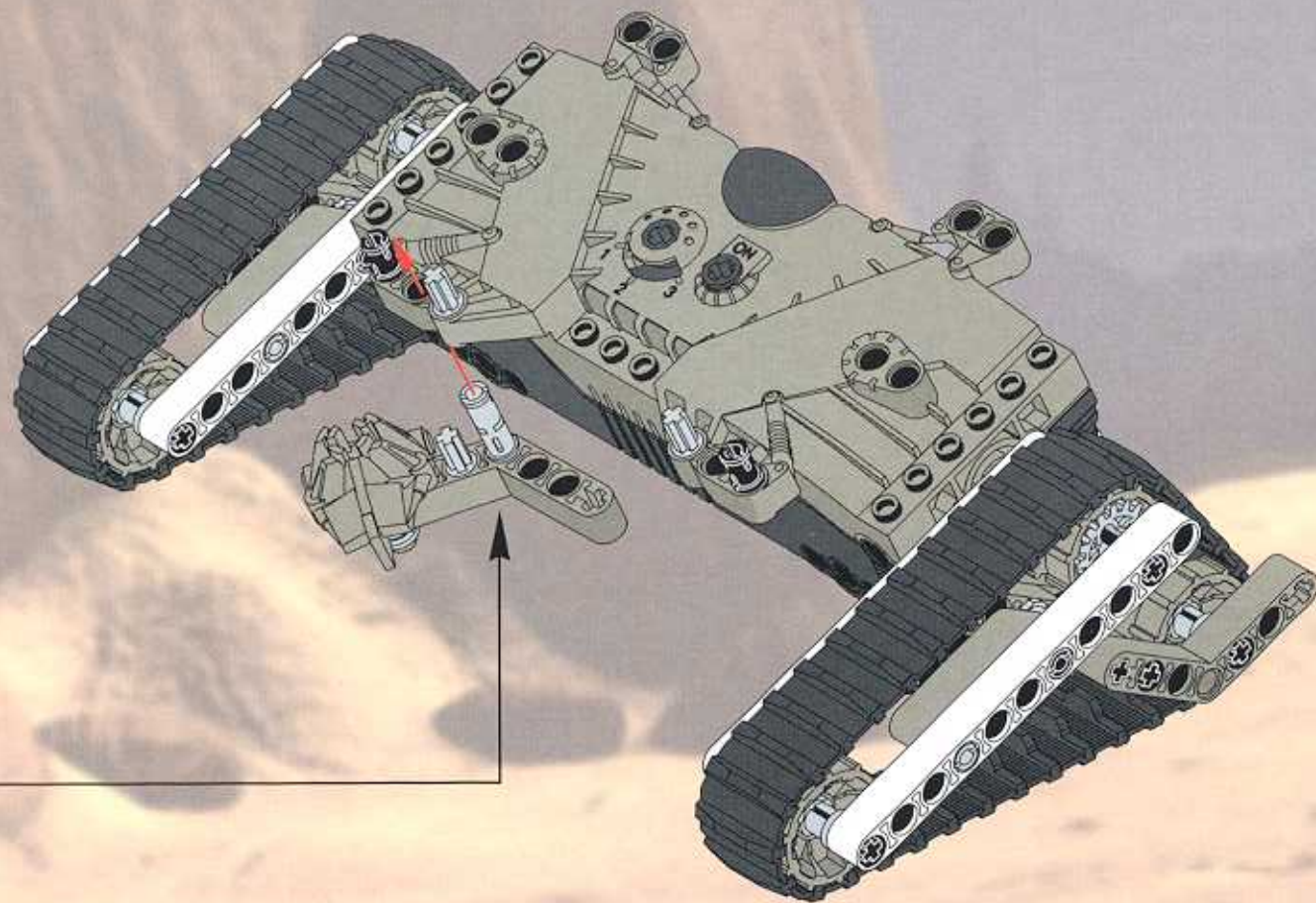
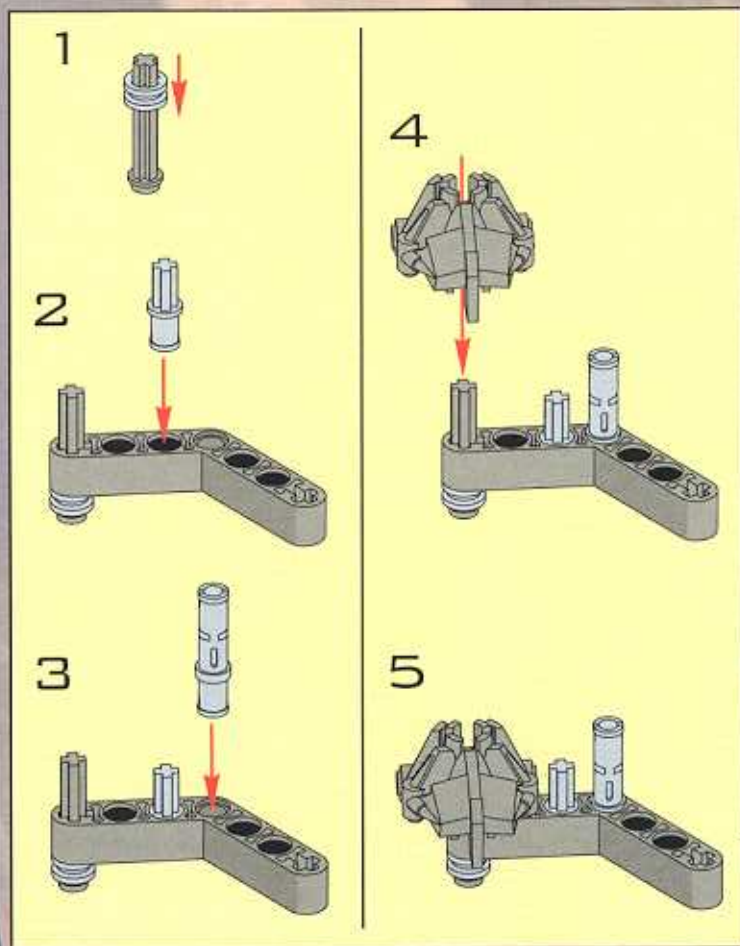

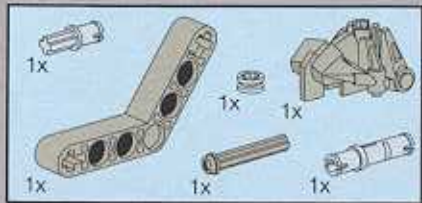

31

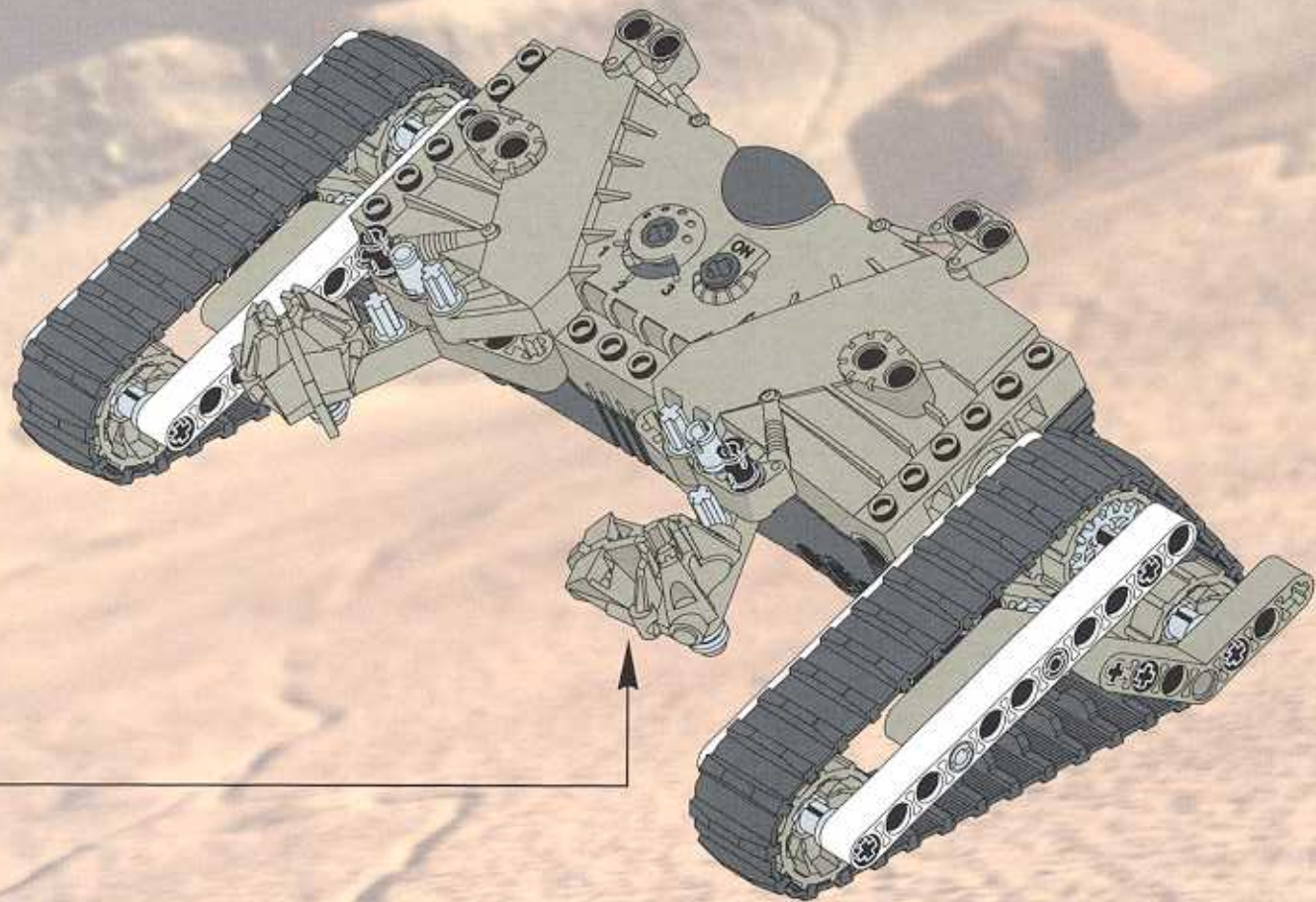
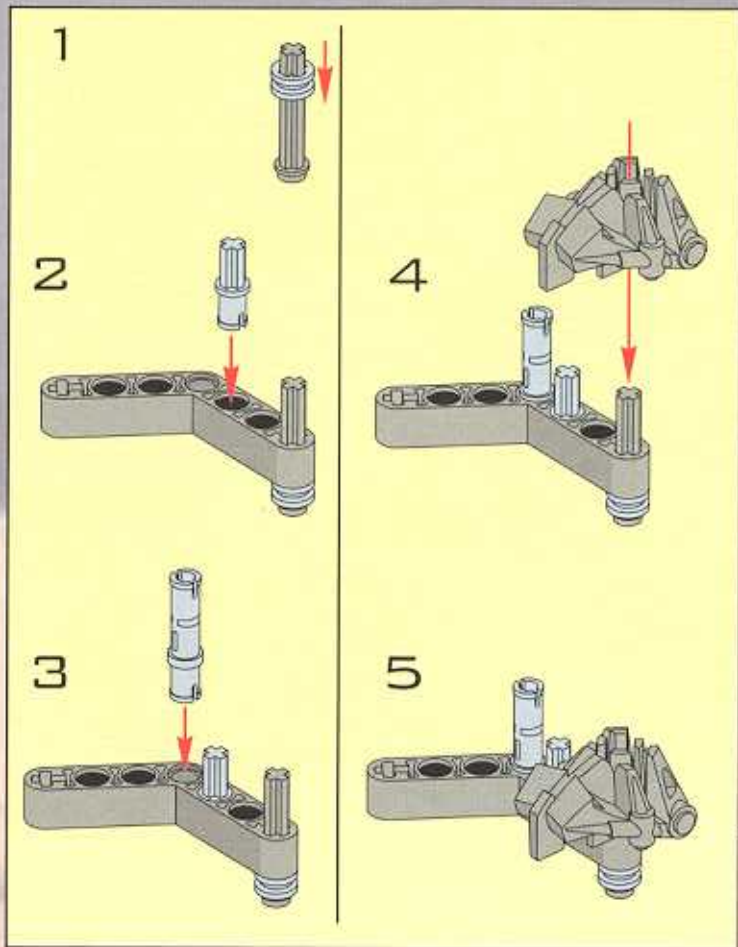

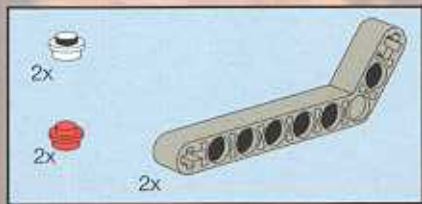

32

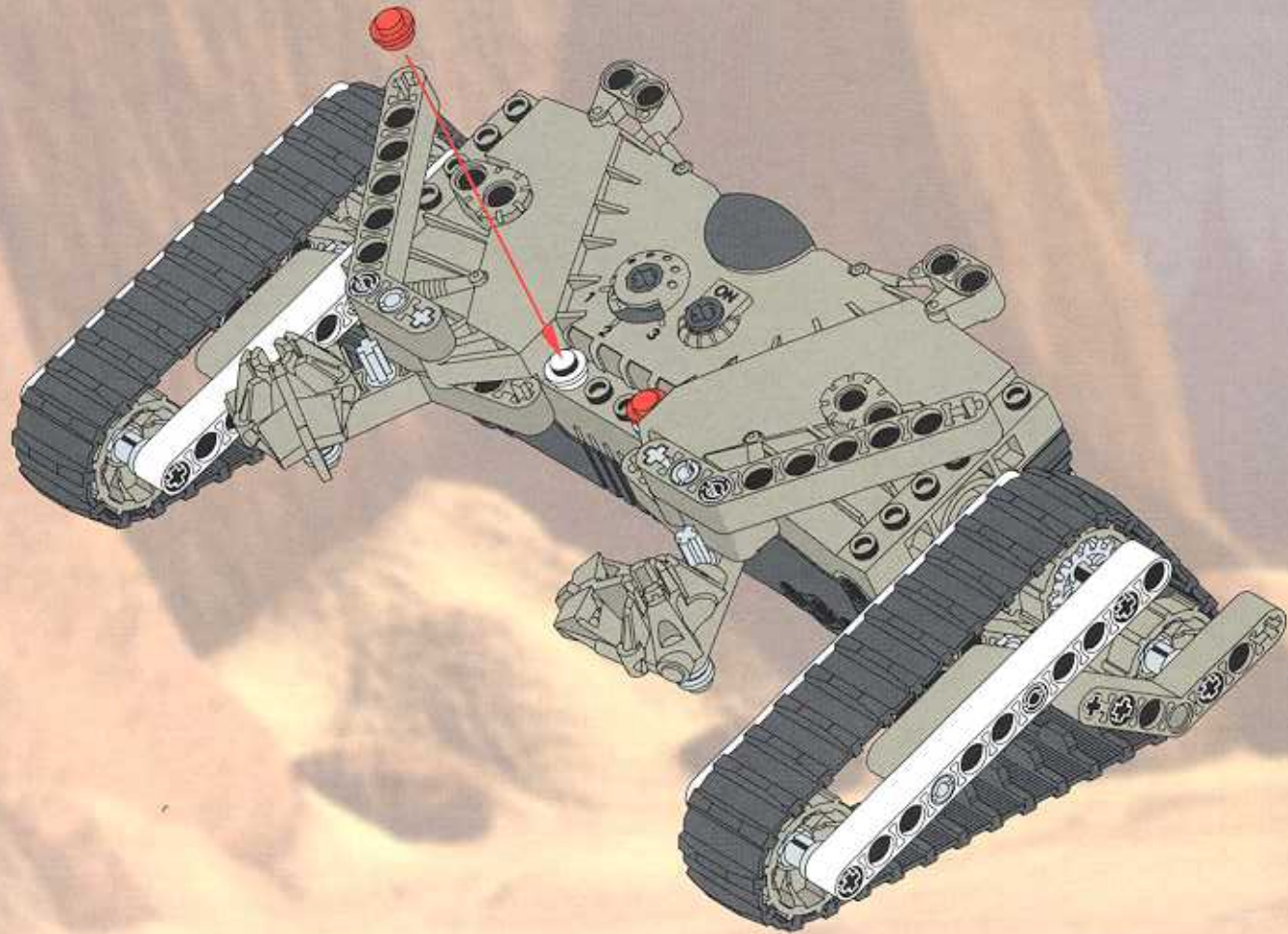

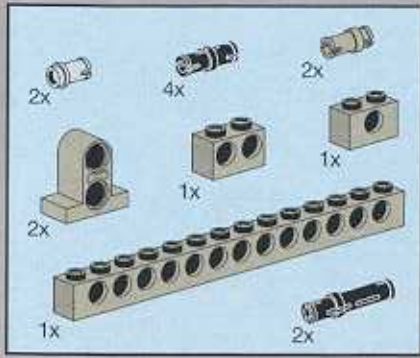

33

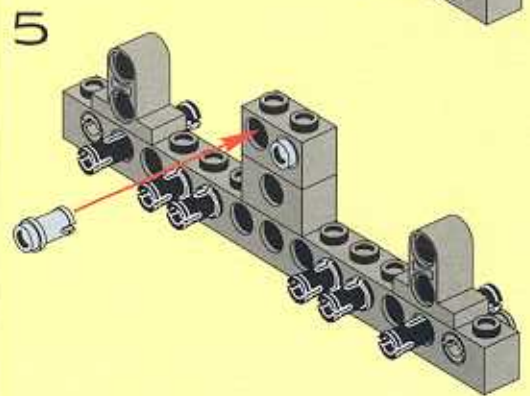
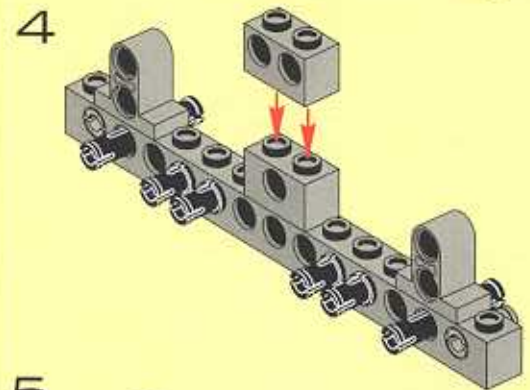
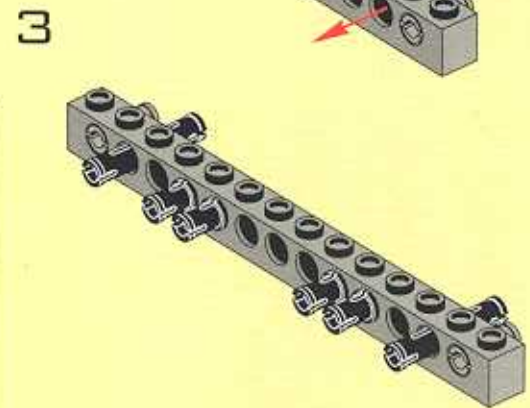
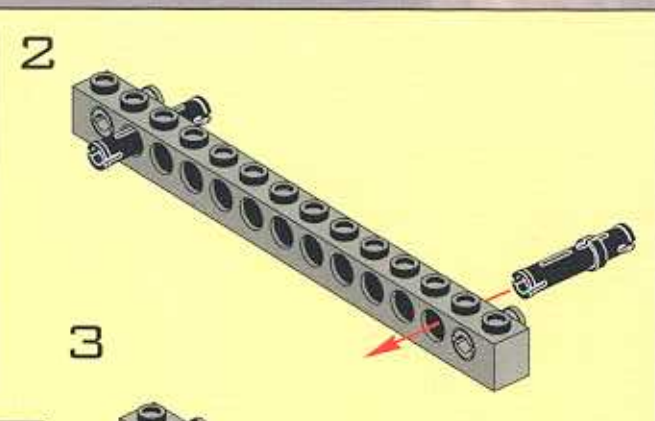
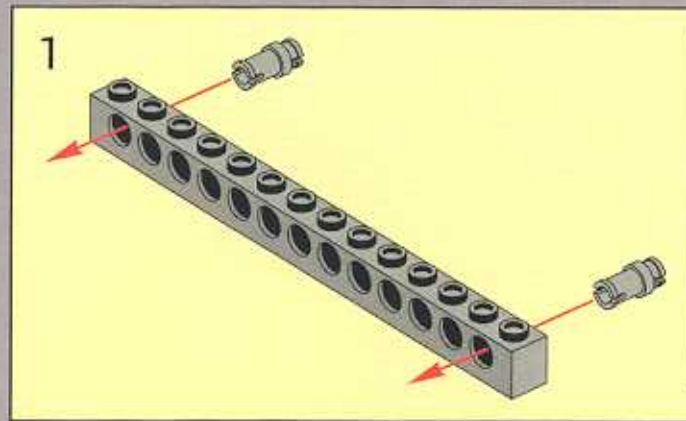
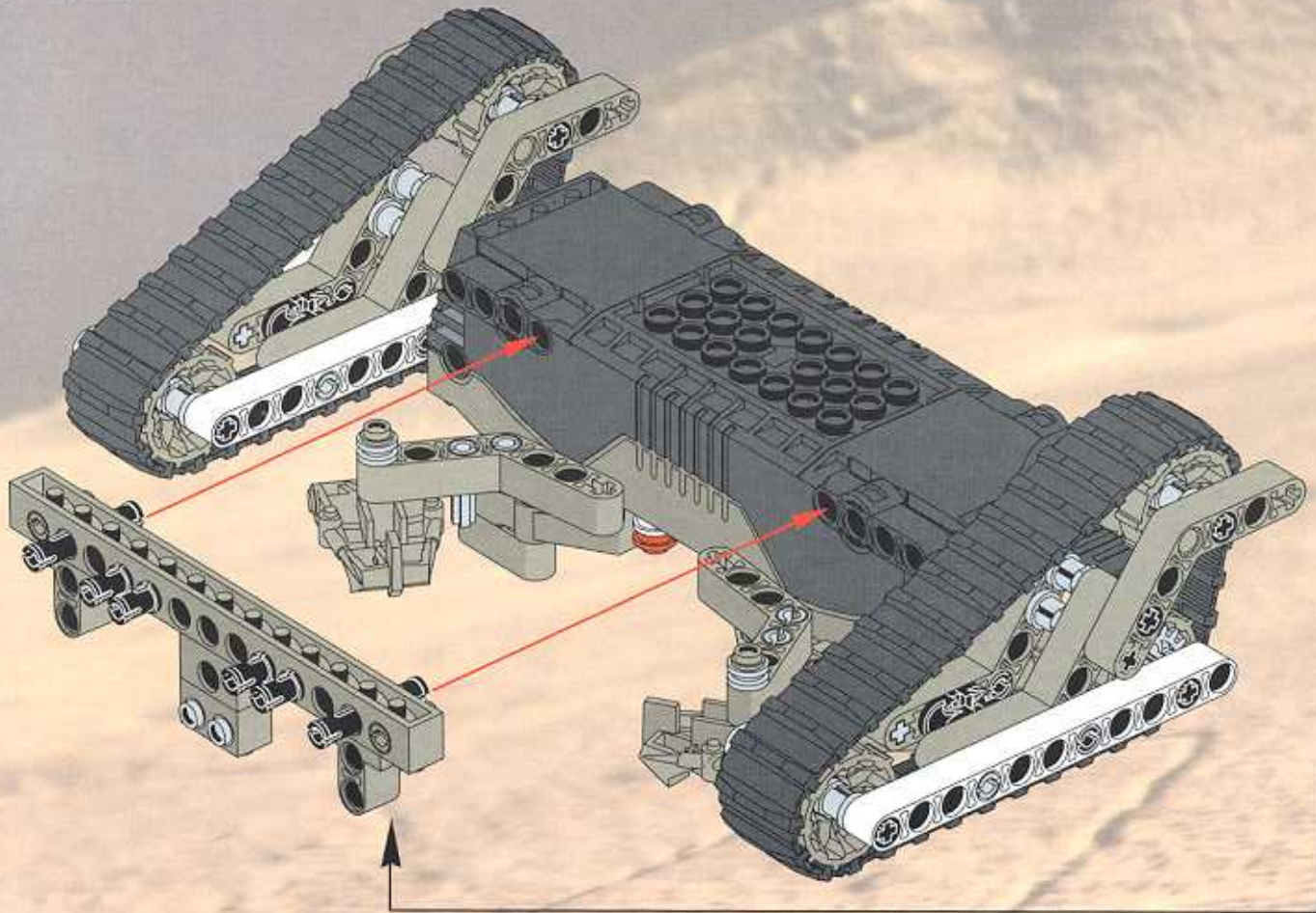

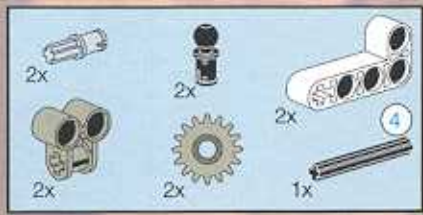

34

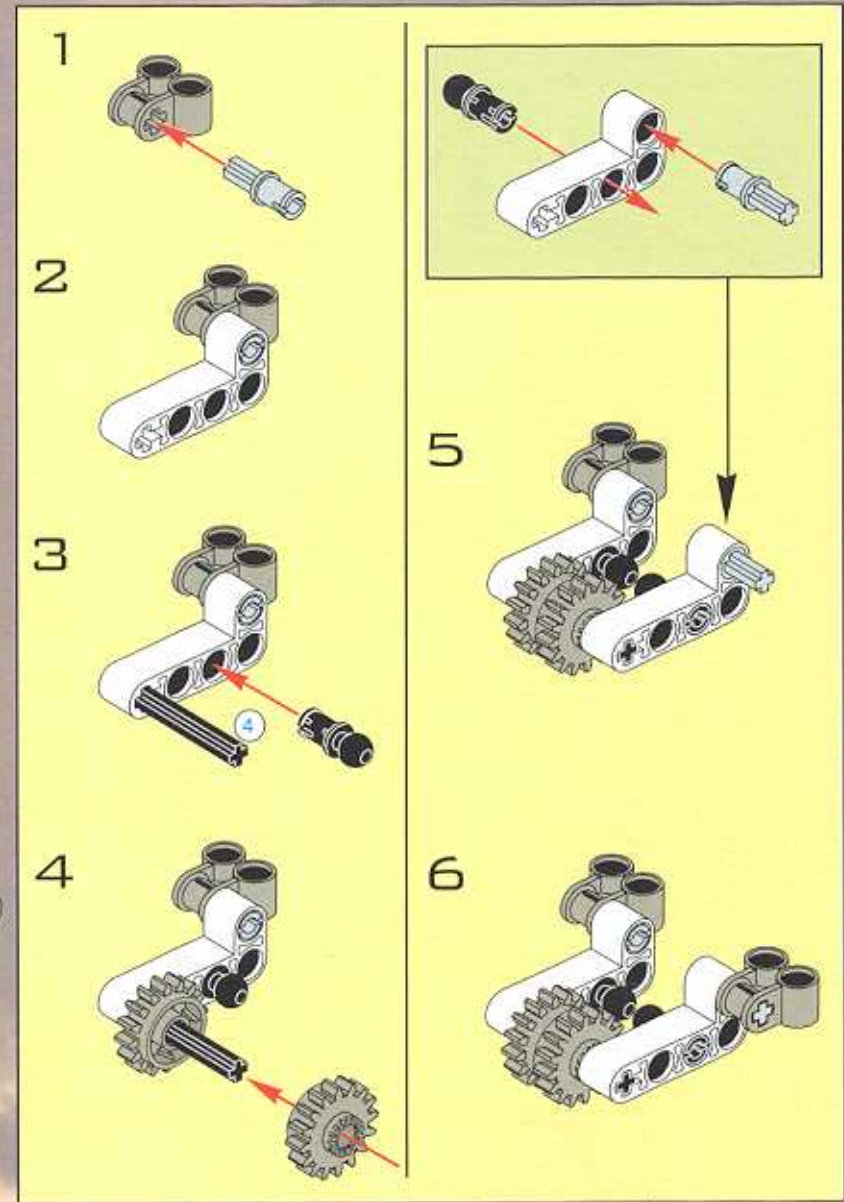
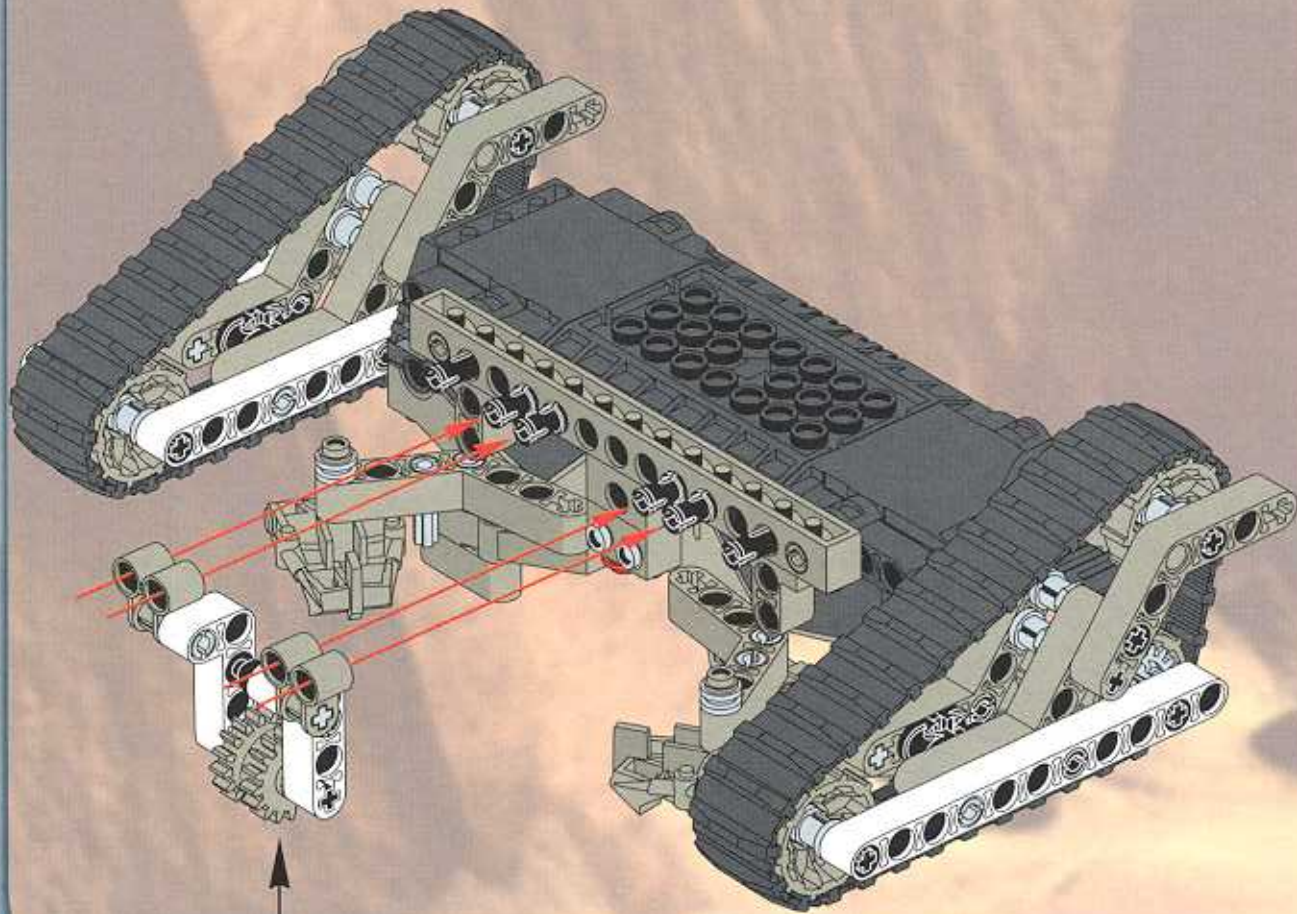

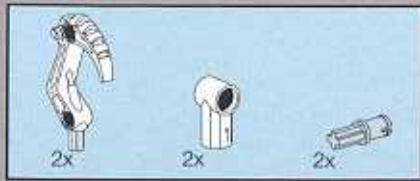

35

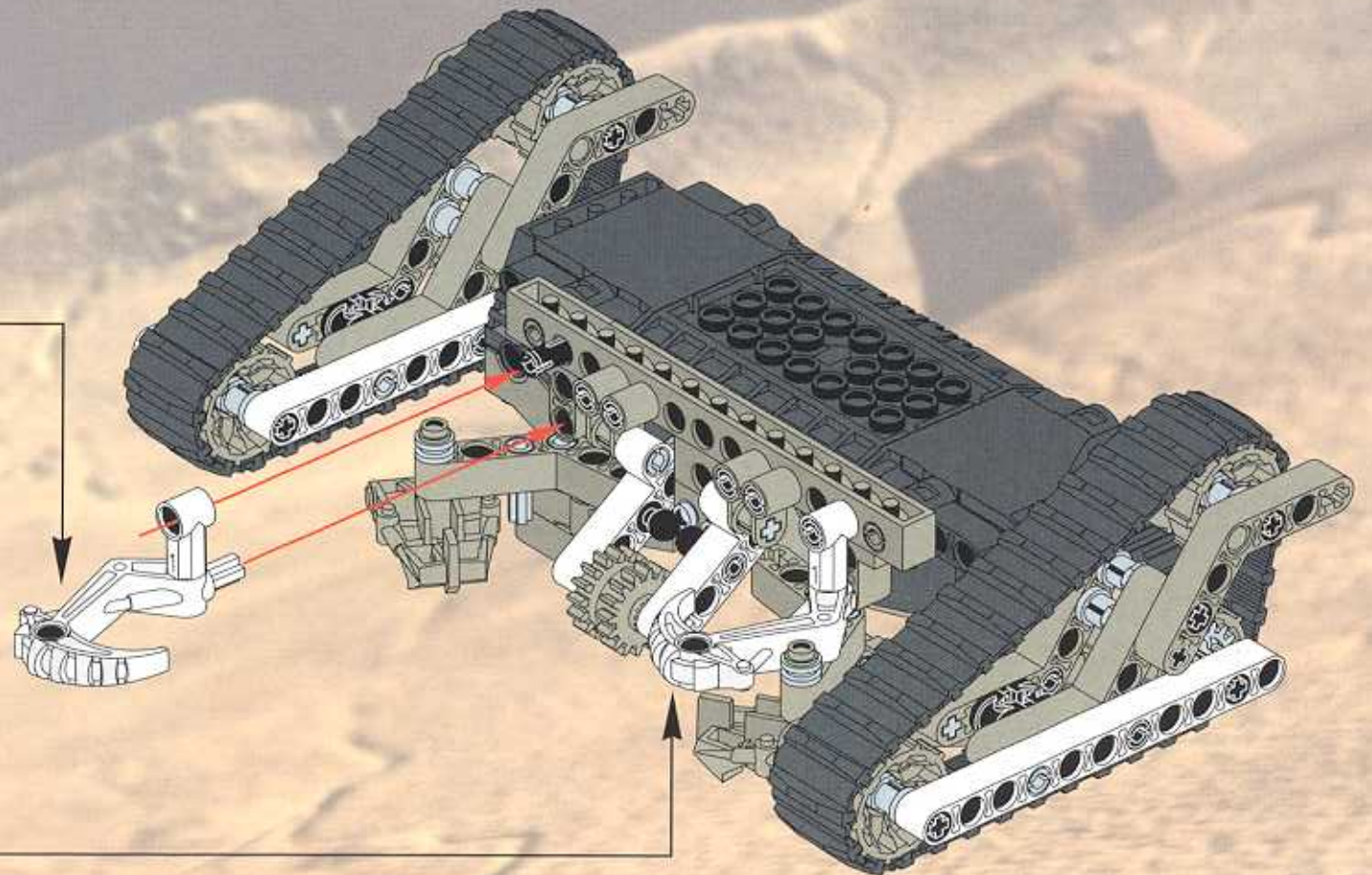
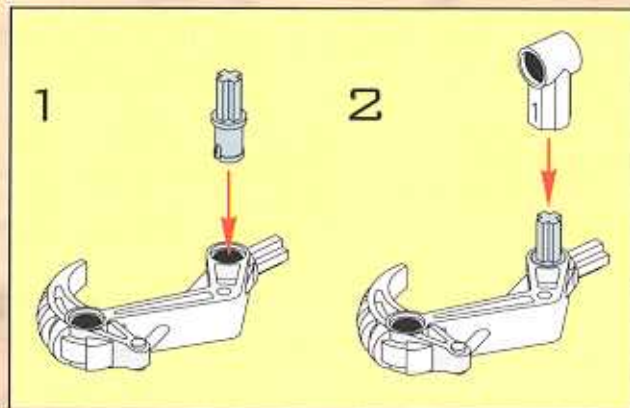
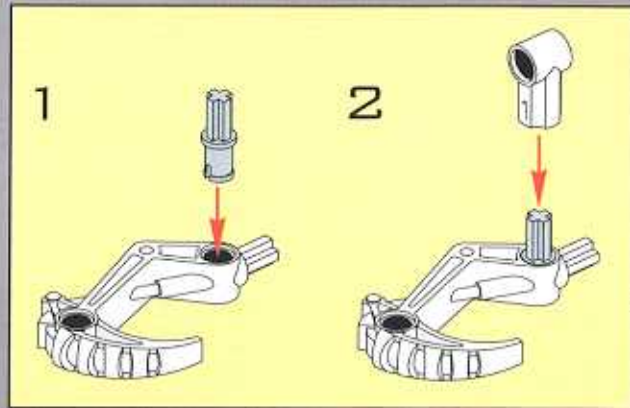



36

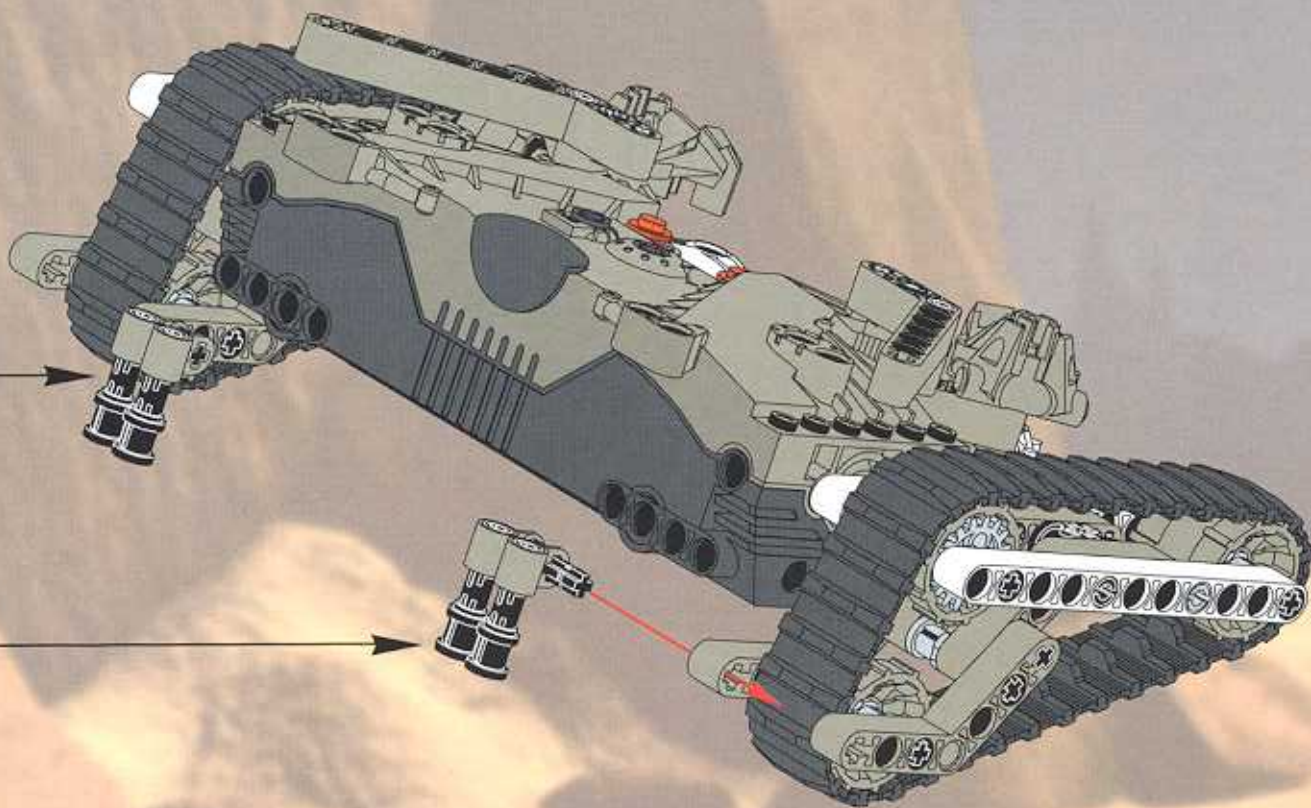
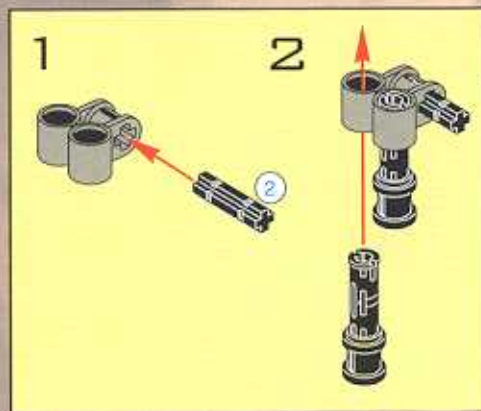
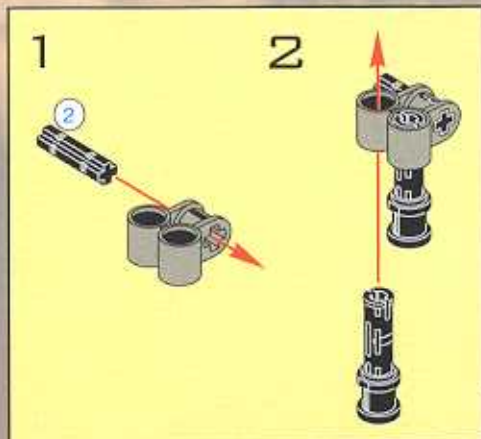

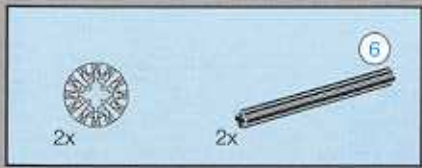

37

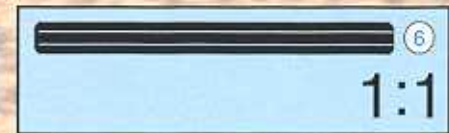
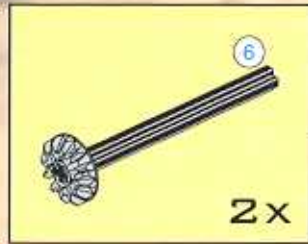
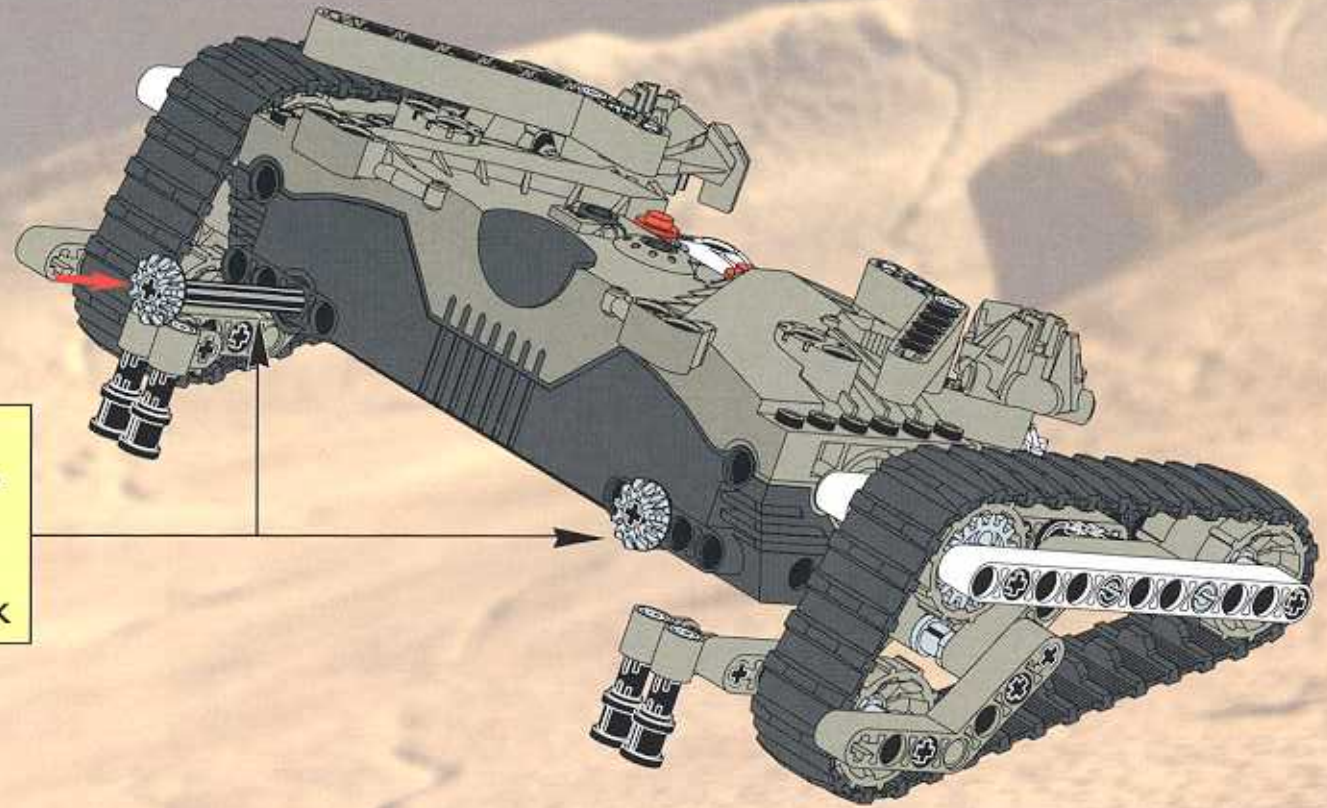



39

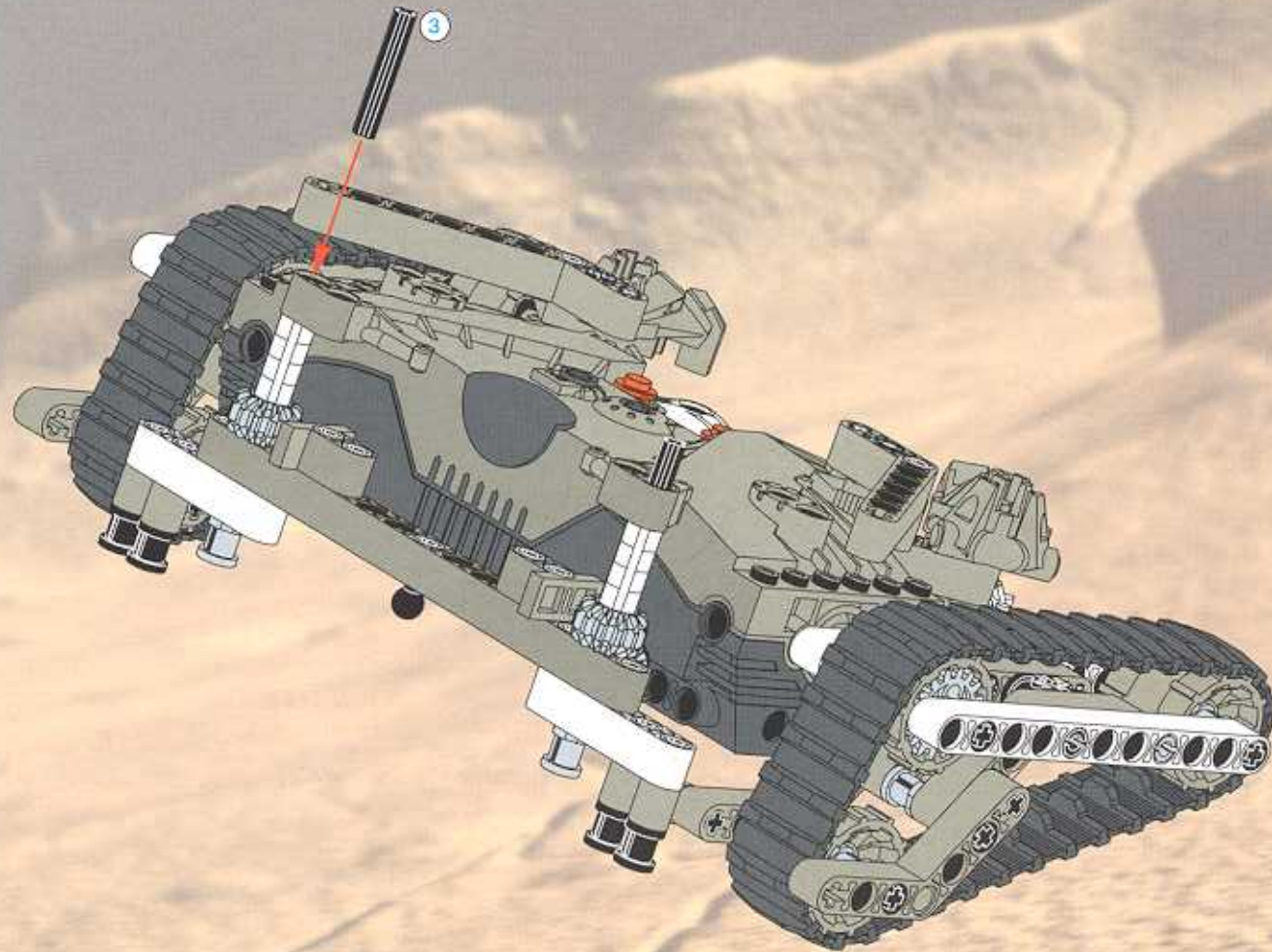

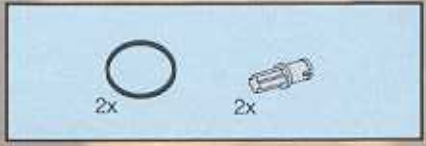

40

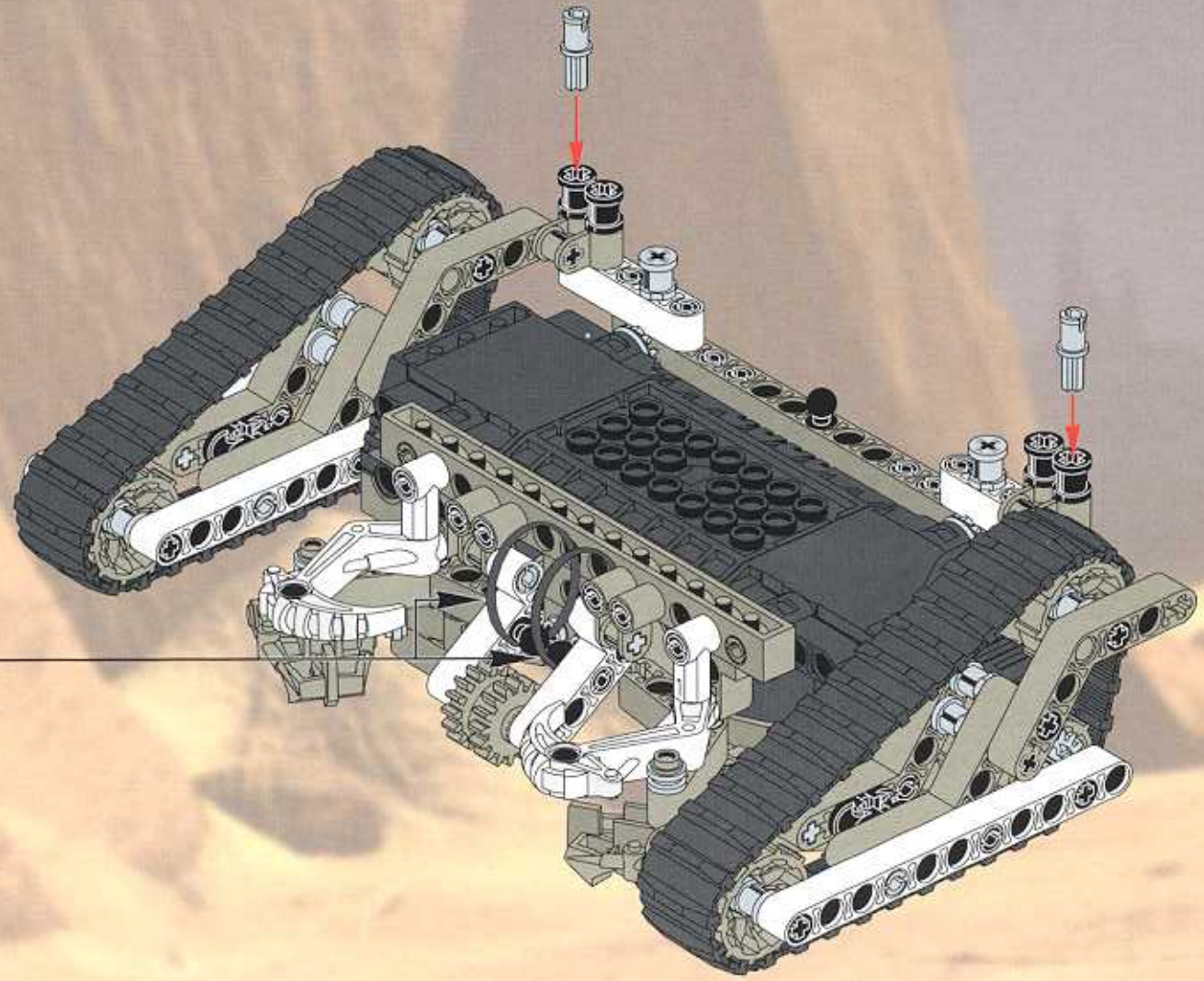
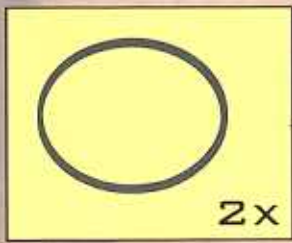



41

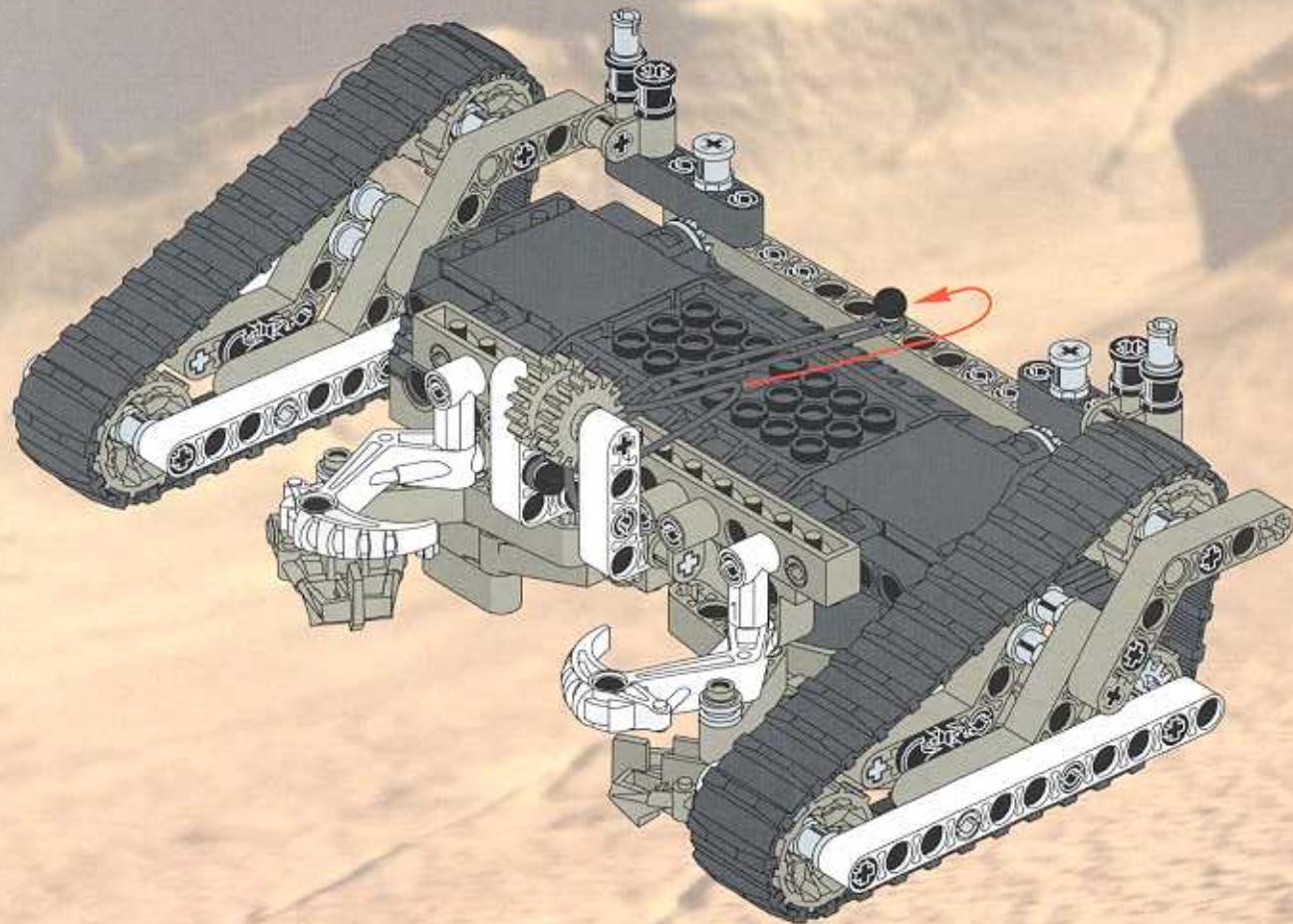



42

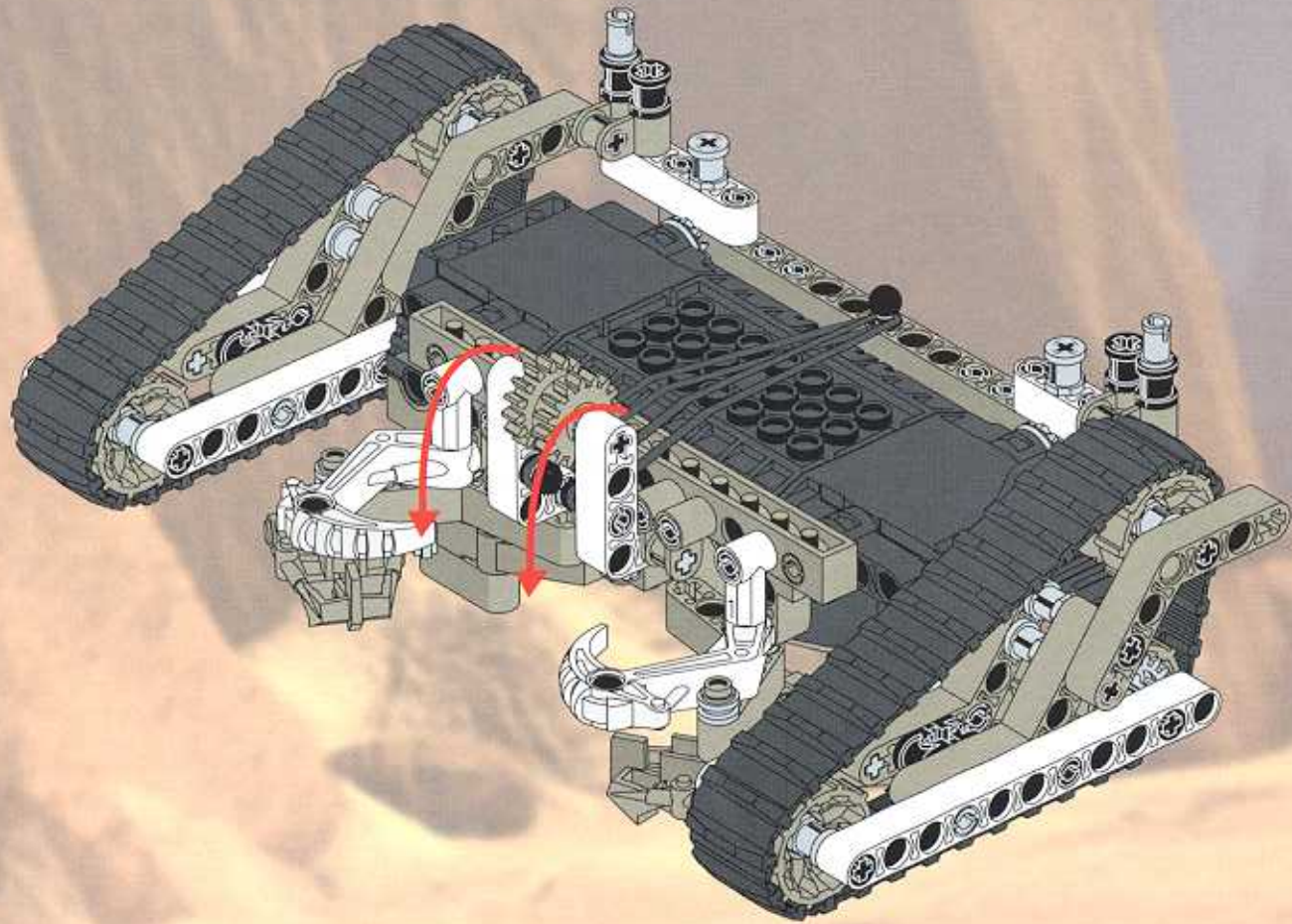



2x

43



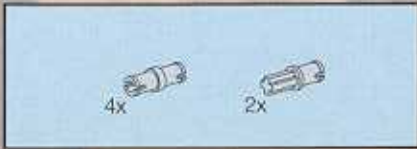

44

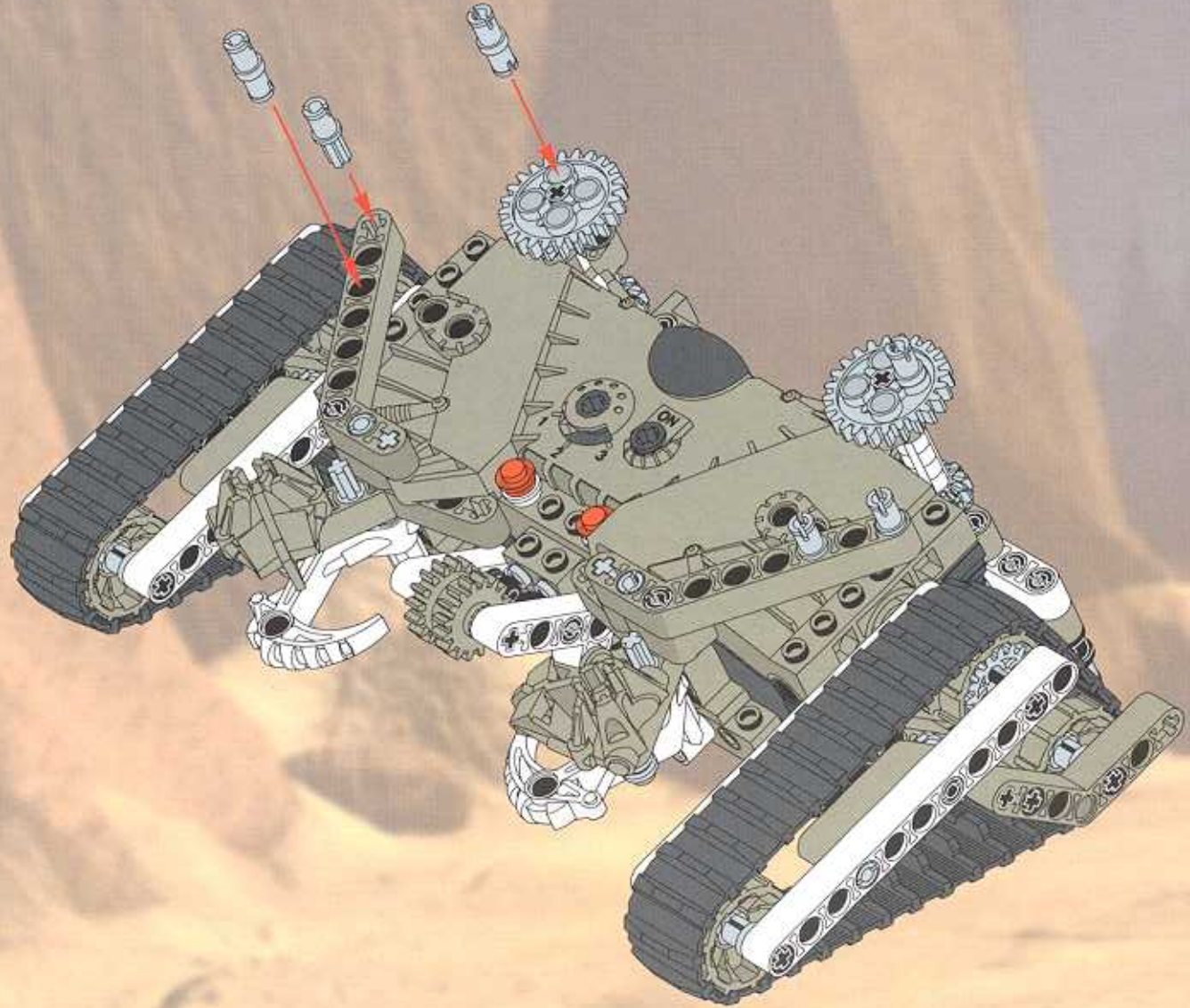

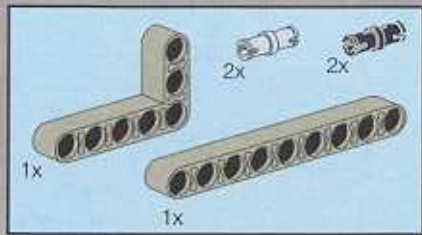

45

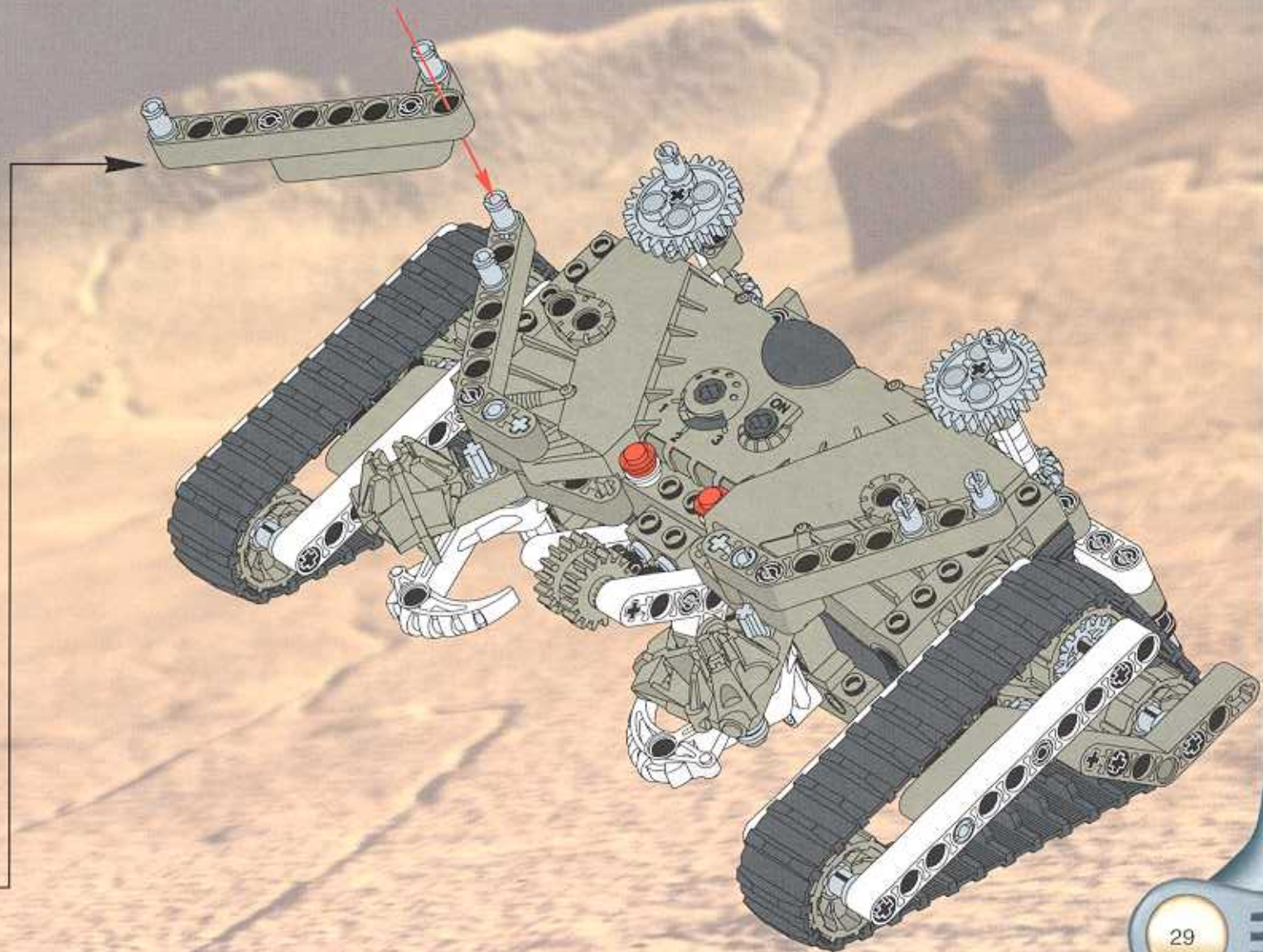
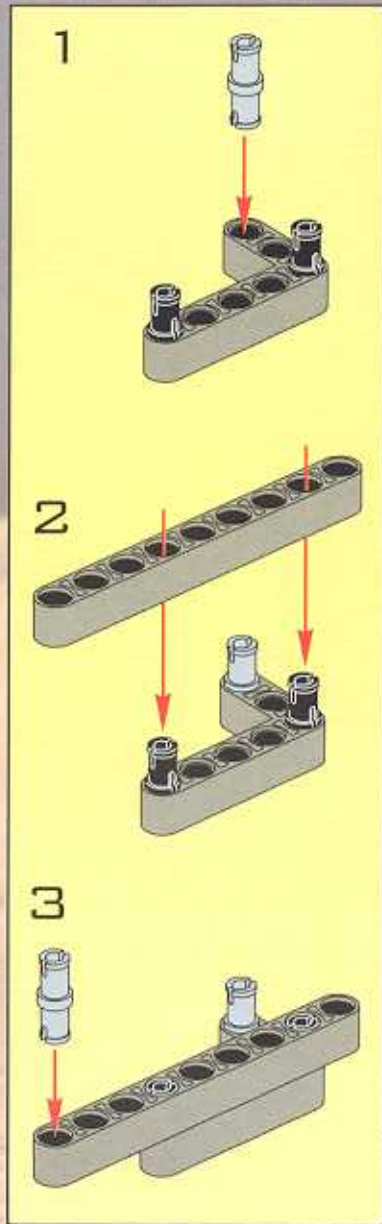

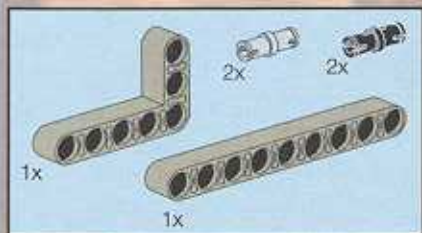

46

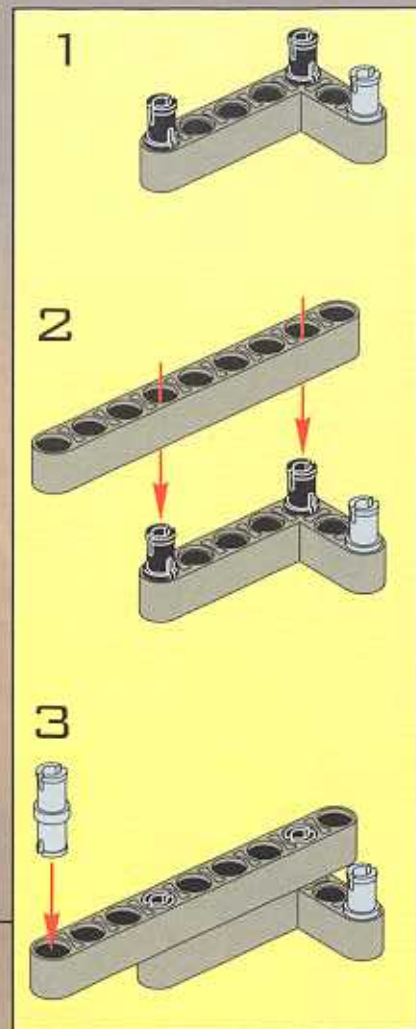
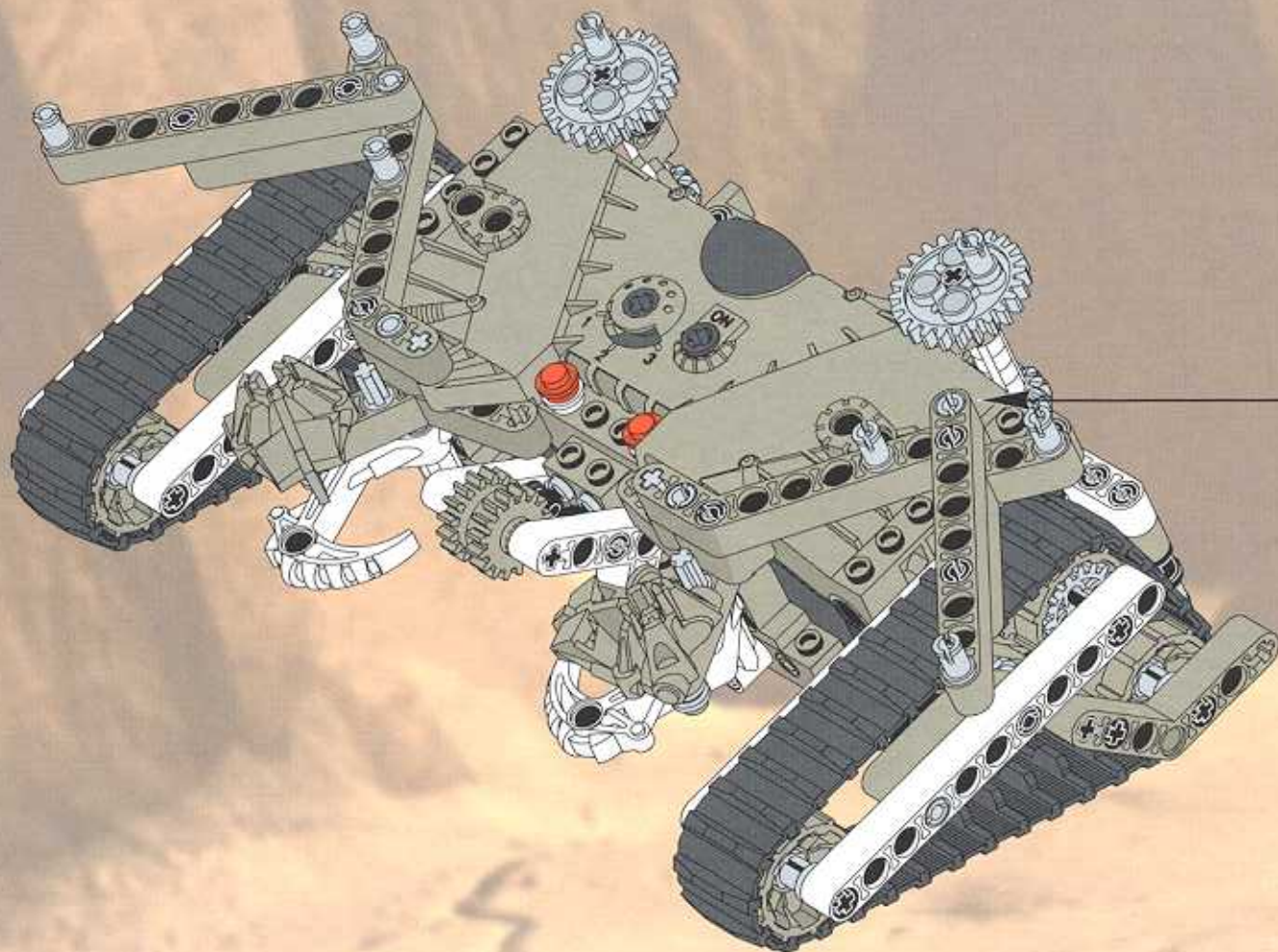

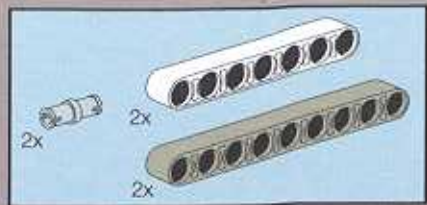

47

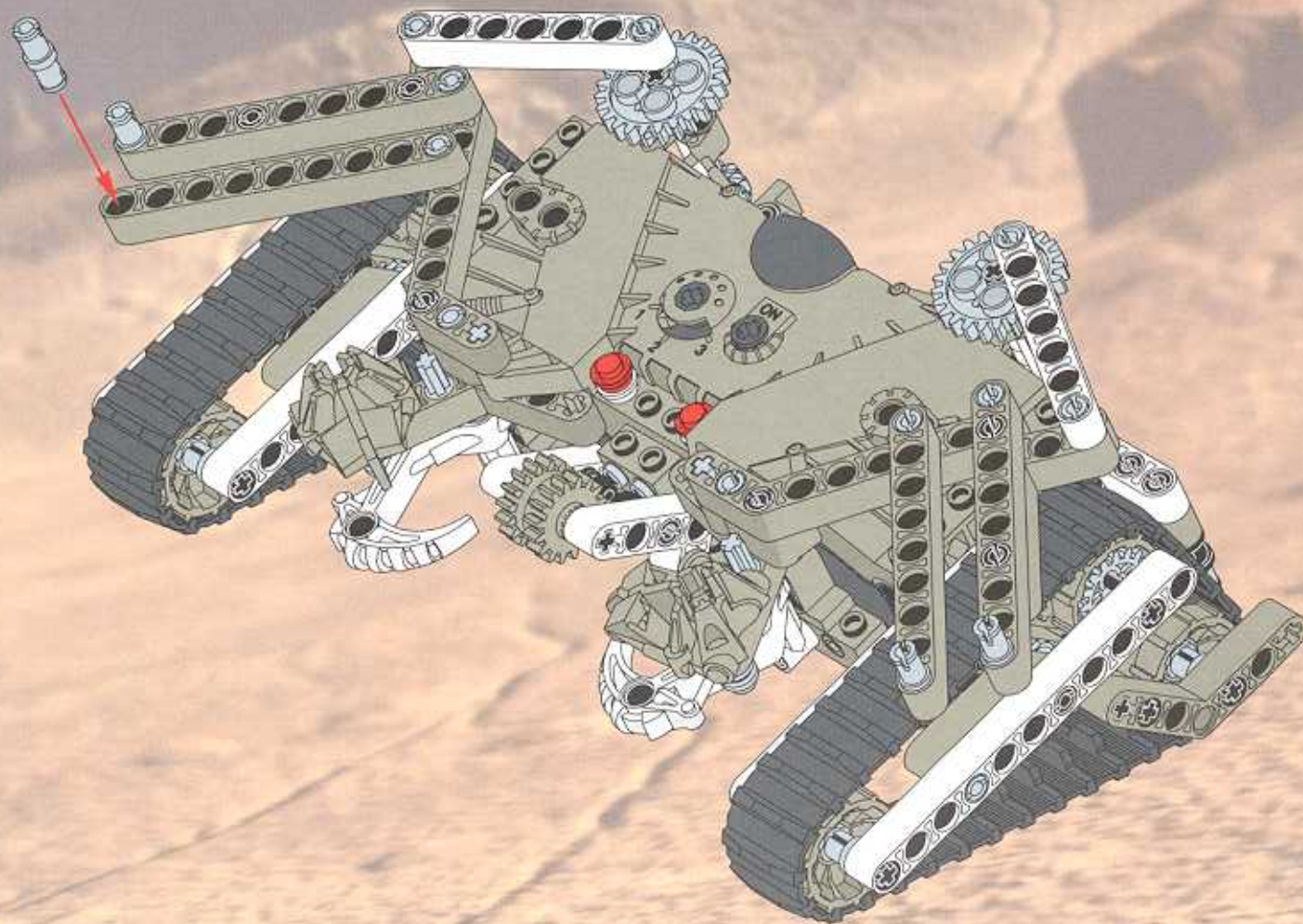

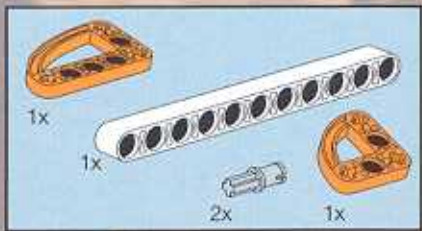

48

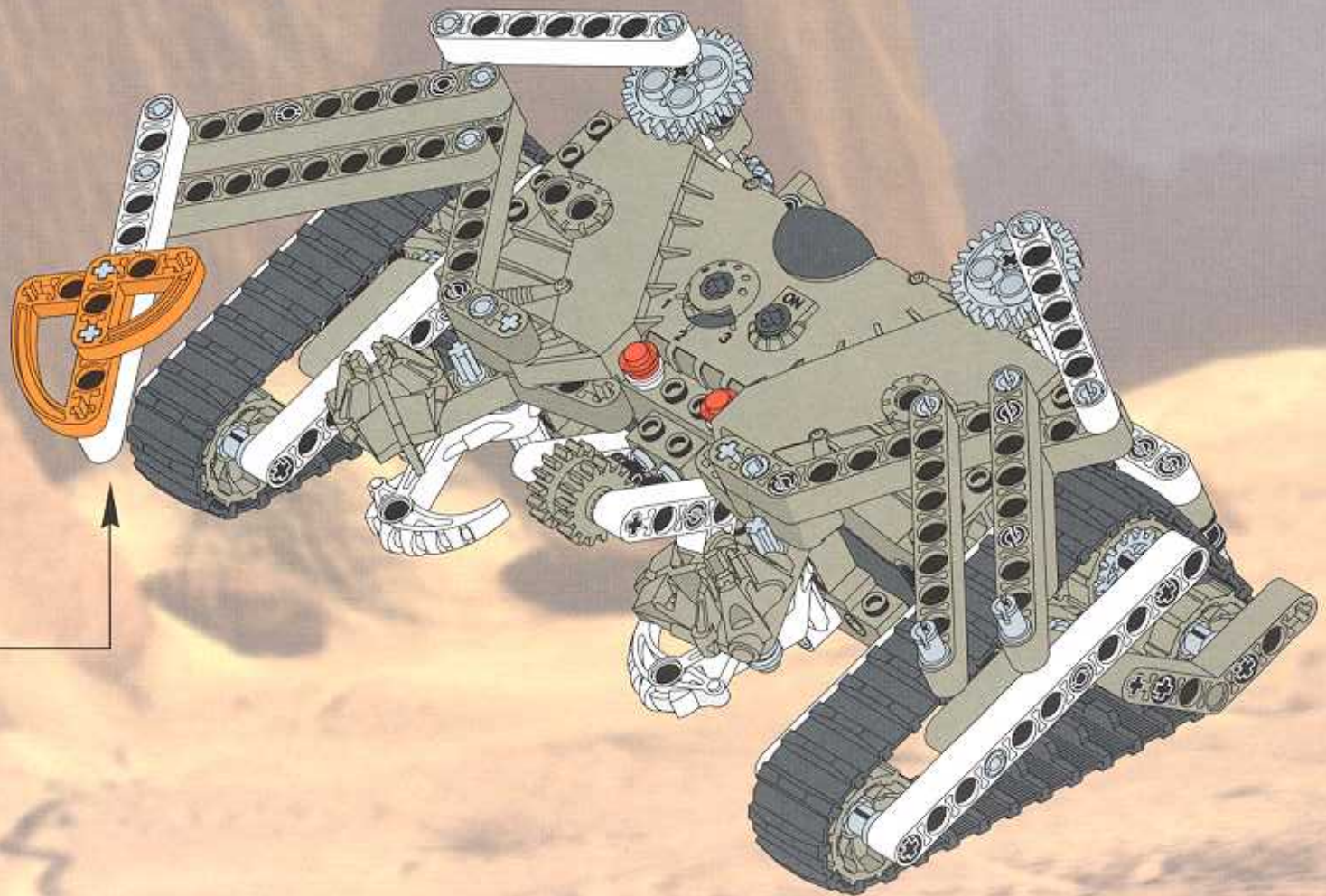
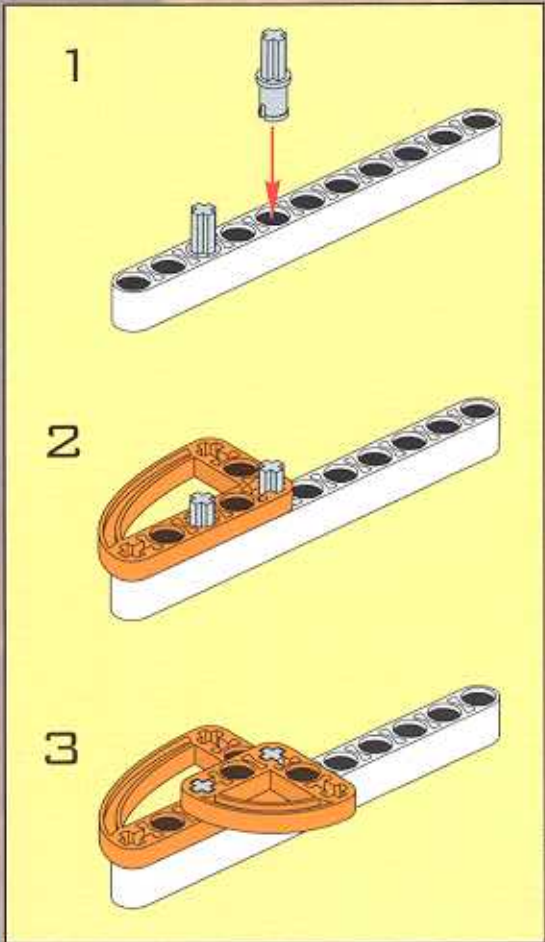

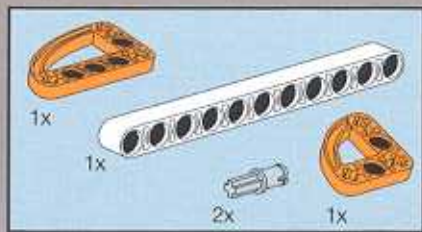

49

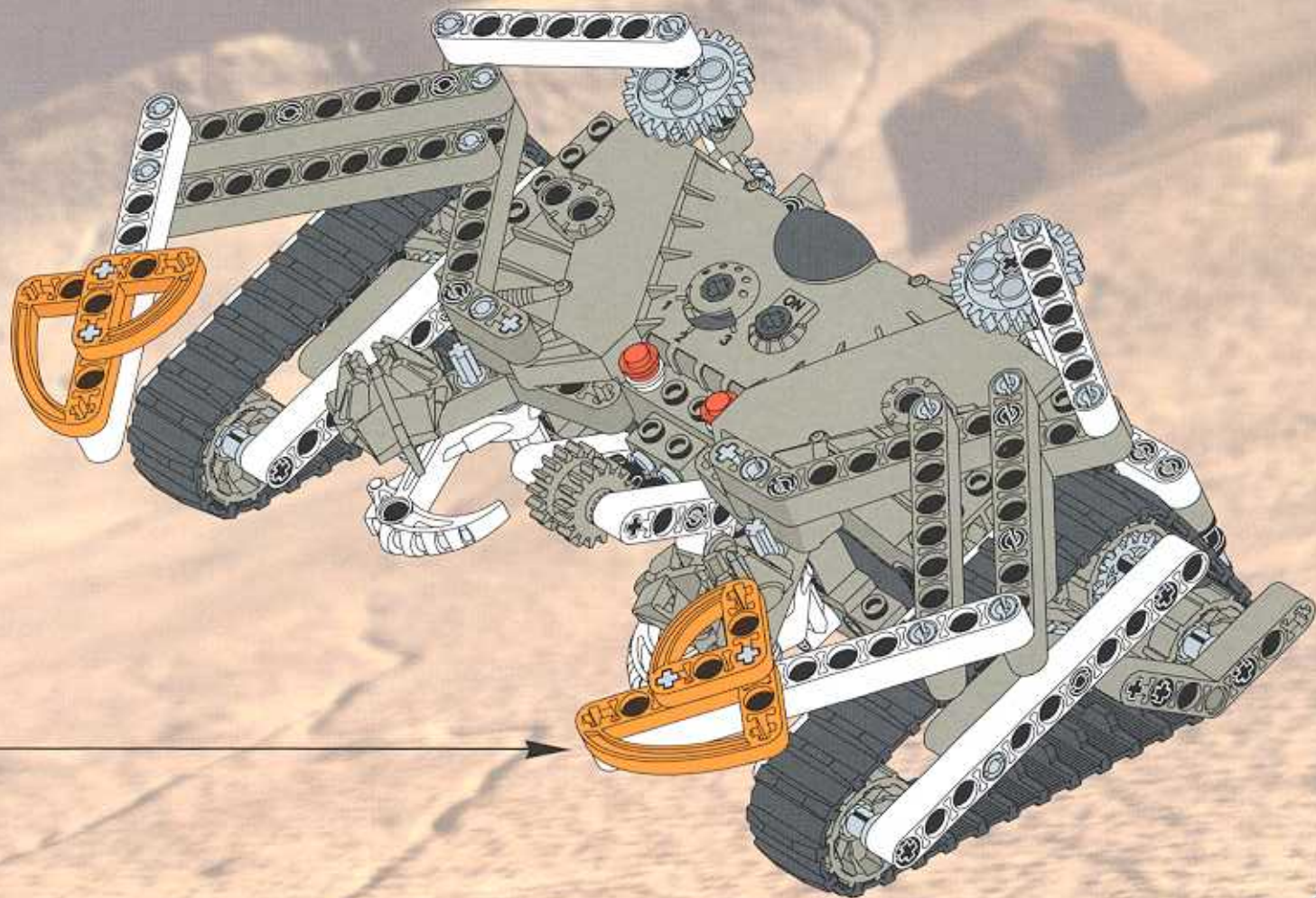
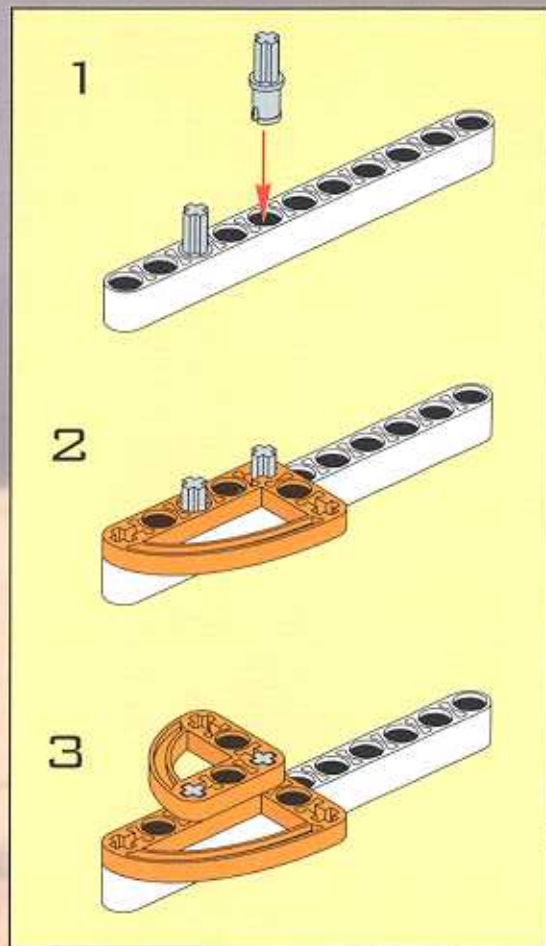

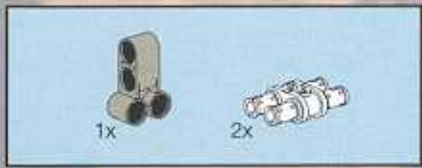

1

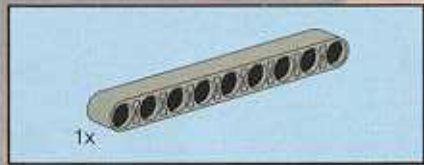
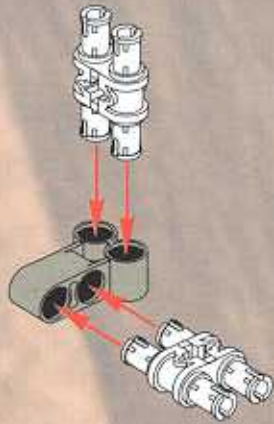

2

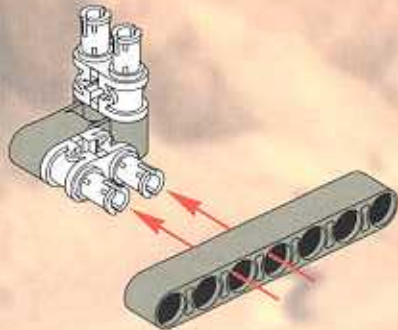

3

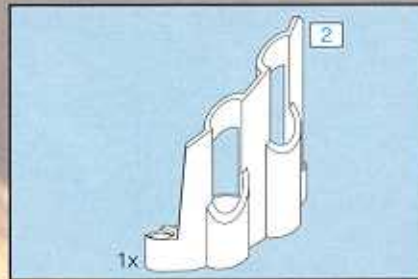
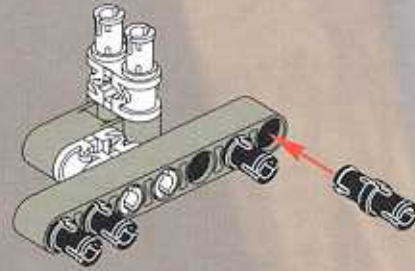

4

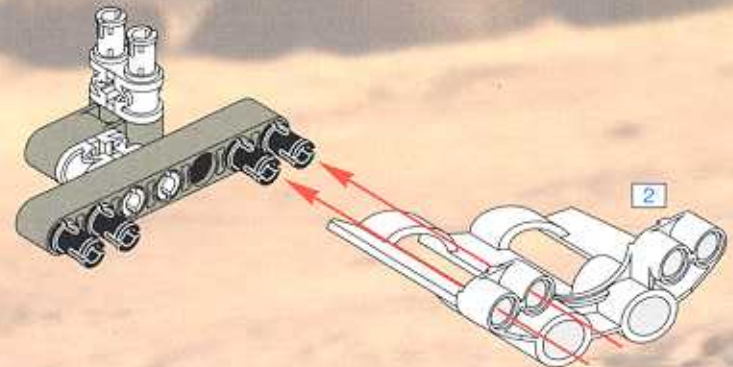

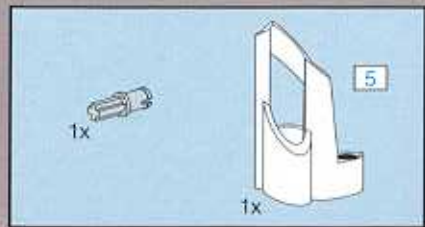

5

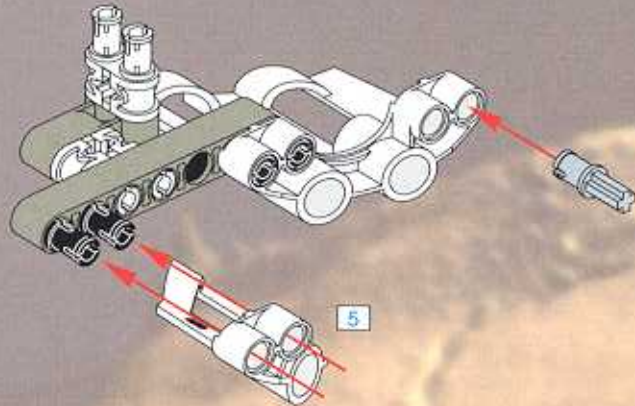

6

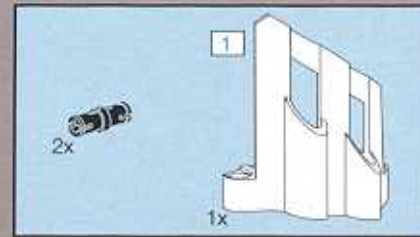
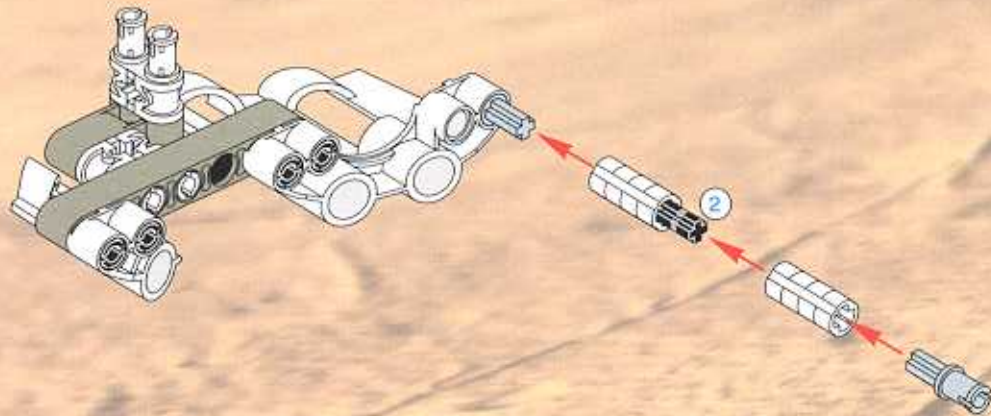

7

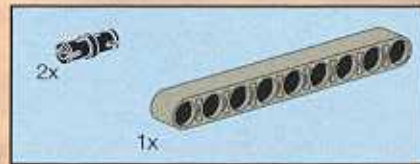
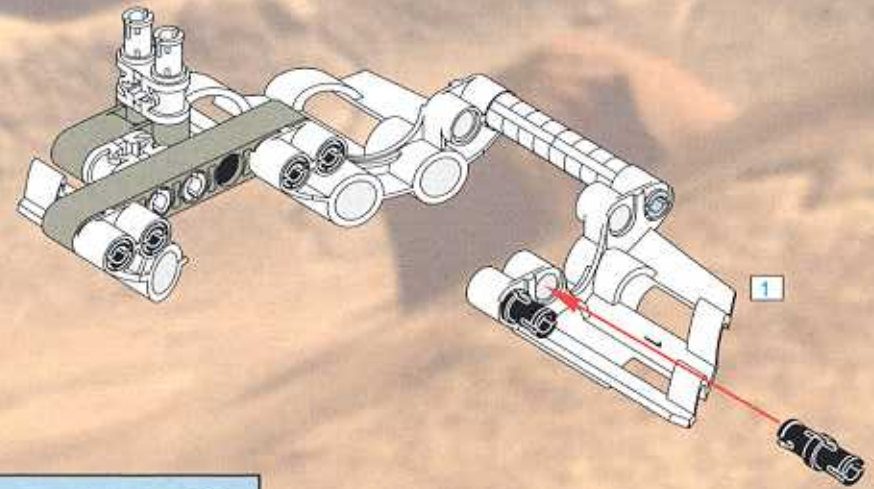

8

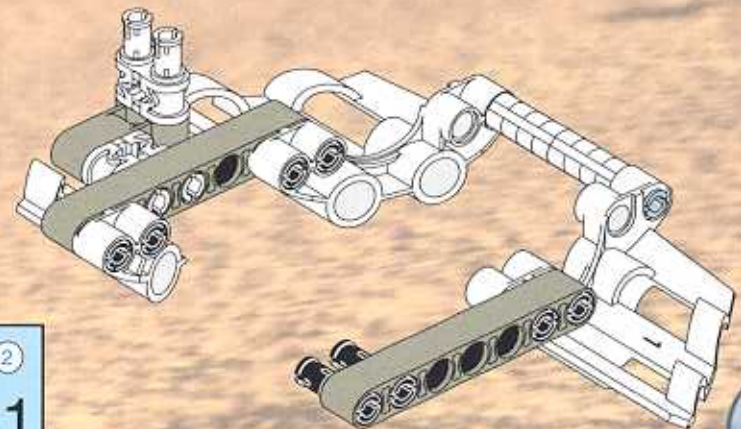

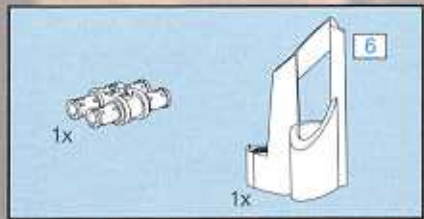

9

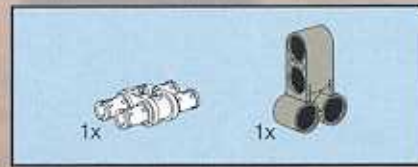
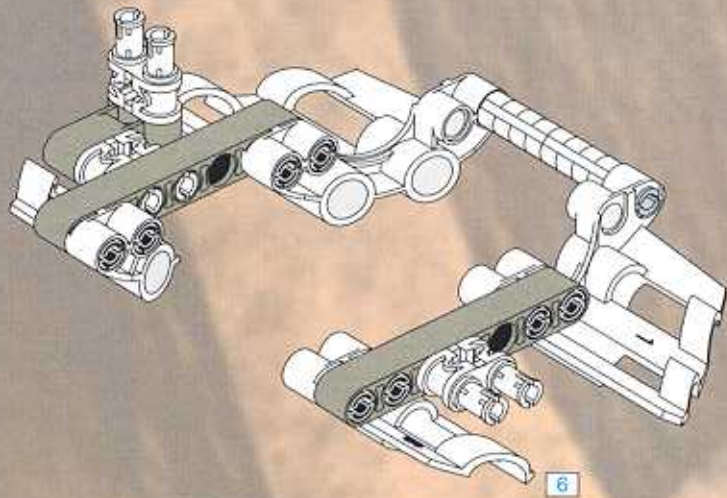

10

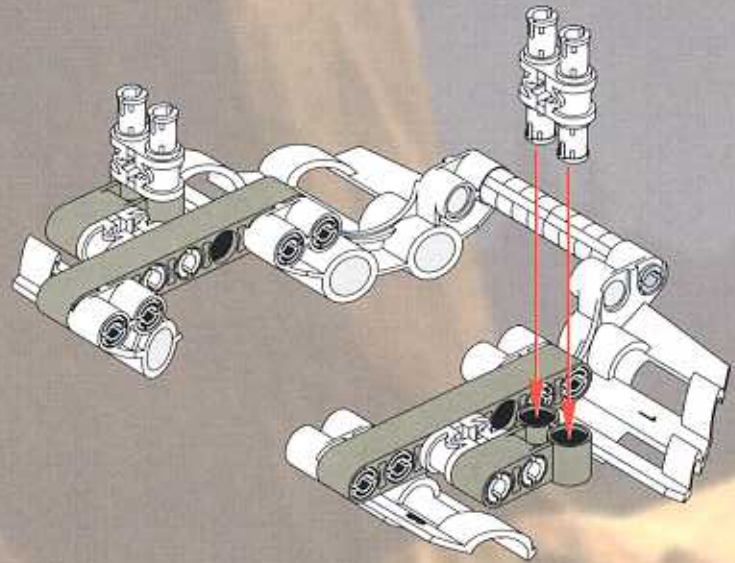

50

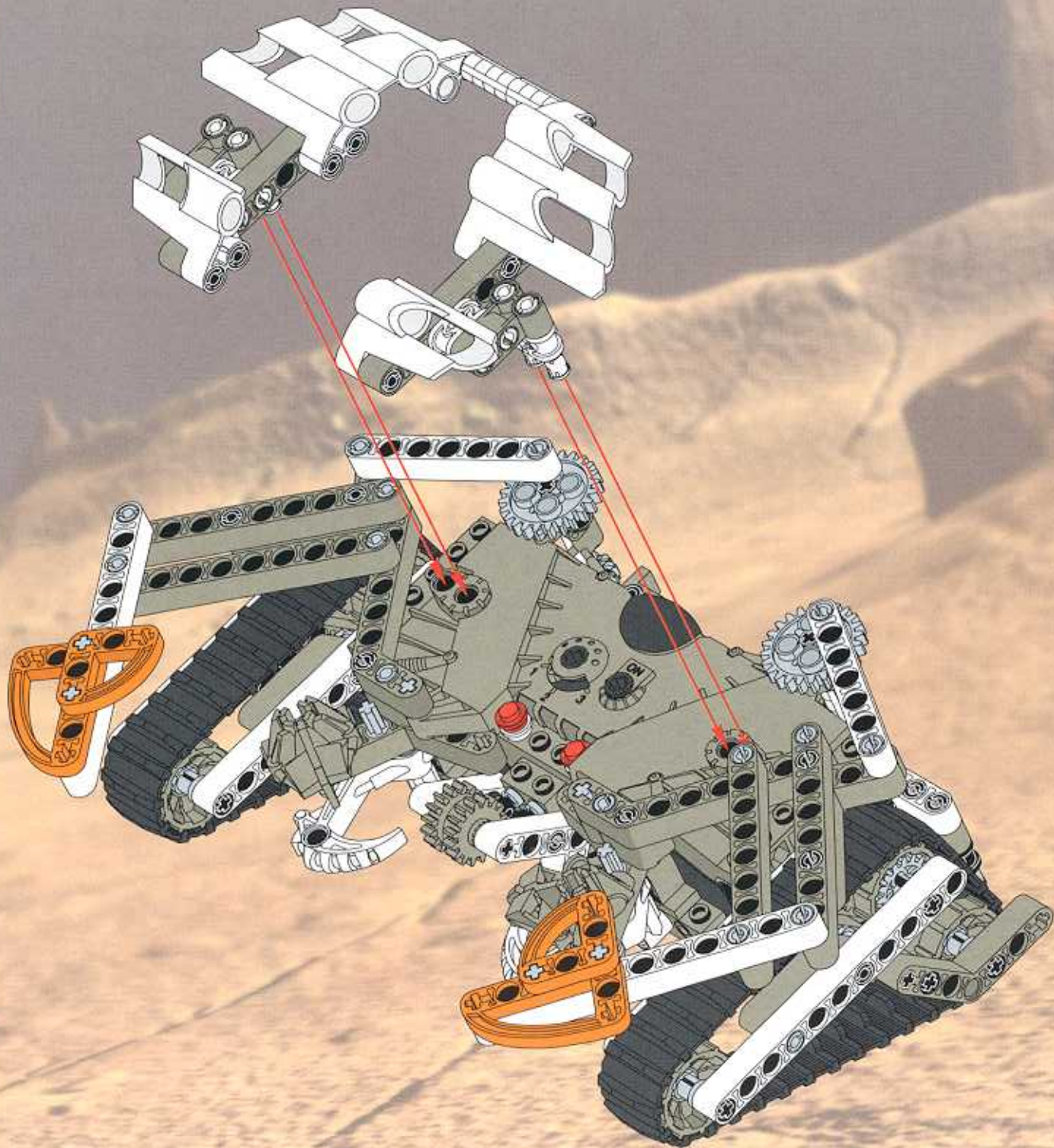



51

